



Here at Unikoo, we strive to provide our customers with accessibility and variety. Our staff is trained to uphold the utmost professionalism while striving to provide you with quality glass and hardware tailored just for you at the most competitive prices. Our experienced team is able to provide all of our clients with completely custom made orders for any enclosure. The possibilities are endless.



Our vision

Additionally, we are proud to offer the perfect package of deluxe shower doors along with modern railing systems crafted for the personal or commercial space. Additionally, we offer pristine quality glass, dependable and beautifully designed hardware, and all of the essential accessories you will need with an easy to navigate online interface that takes the guesswork out of your shopping experience. Not only are all of our products custom made orders unique in design and quality, we are proud to offer same day shipping and processing due to our expanded inventory and dedicated team.



Our company, possessing more than 15 years of expertise, has experienced phenomenal growth in terms of both the variety of products and the quantity of stock since its establishment. This has led to a steady rise in profits annually, positioning us as a promising provider for all your glass and hardware needs.



Commercial Product

Commercial Handrail Hardware	03-16
Commercial Clamps	17-18
Commercial Pulls	19
Commercial Handles / Looks	20-21
Commercial Door Patch Hardware	22-23
Commercial Door Hardware Sets	24-25

Sliding Door

Sliding Door Units	26-32
Photo Gallery	33
Plastic Seals	34-35

Swing Door Accessories

Standard Hinges	36-38
Heavy Duty Hinges	38-42
Glass Clamps	42-46
Shower Door Header Accessories	47-48
U Channel / J Channel / L Profile	49
Glass Support Bars	50
Handles / Towel Bars	51-55
Door Knobs	56-57
Door Stop / Robe Hooks	58

Accessories

Sealants / Cleaners	59
Accessories	60-61

Commercial Handrail Hardware

120" Square Base Shoe Set

- Includes base shoe, 2pcs. cladding, and accessories
- For 1/2" to 9/16" laminated tempered glass

Item #	Color	Pack
CBSA120-CH	Chrome	1 Set
CBSA120-BN	Brushed Nickel	1 Set
CBSA120-MBL	Matte Black	1 Set



240" Square Base Shoe Set

- Includes base shoe, 2pcs. cladding, and accessories
- For 1/2" to 9/16" laminated tempered glass

Item #	Color	Pack
CBSA240-CH	Chrome	1 Set
CBSA240-BN	Brushed Nickel	1 Set
CBSA240-MBL	Matte Black	1 Set



120"/240" Square Base Shoe - 1/2" Glass

- For 1/2" laminated tempered glass
- Base shoe only

Item #	Length	Pack
CBSA120	120"	1 Pc.
CBSA240	240"	1 Pc.



120" Straight Cladding

- Straight cladding for 120" long heavy duty base shoe
- 304 Stainless steel

Item #	Color	Pack
CBSC120-CH	Chrome	1 Pc.
CBSC120-BN	Brushed Nickel	1 Pc.
CBSC120-MBL	Matte Black	1 Pc.



240" Straight Cladding

- Straight cladding for 240" long heavy duty base shoe
- 304 Stainless steel

Item #	Color	Pack
CBSC240-CH	Chrome	1 Pc.
CBSC240-BN	Brushed Nickel	1 Pc.
CBSC240-MBL	Matte Black	1 Pc.



Dry Glaze Base Shoe Blocks

- Includes 9 sets of blocks for dry glaze base shoe

Item #	Pack
CBSACC04	9 Sets/Box



Base Shoe End Cap

- Stainless end cap for CBS series standard square base shoe

Item #	Color	Pack
CRRCAP01-CH	Chrome	1 Pc./Box
CRRCAP01-BN	Brushed Nickel	1 Pc./Box
CRRCAP01-MBL	Matte Black	1 Pc./Box



120" Heavy Duty Square Wet Glaze Base Shoe Set for 1/2" Glass - Drilled

- Includes base shoe, claddings, and base shoe blocks
- For use with 1/2" (12 mm) monolithic tempered glass

Item #	Color	Pack
CBSAH120SET-BN	Brushed Nickel	1 Set
CBSAH120SET-MBL	Matte Black	1 Set



240" Heavy Duty Square Wet Glaze Base Shoe Set for 1/2" Glass - Drilled

- Includes base shoe, claddings, and base shoe blocks
- For use with 1/2" (12 mm) monolithic tempered glass

Item #	Color	Pack
CBSAH240SET-BN	Brushed Nickel	1 Set
CBSAH240SET-MBL	Matte Black	1 Set



120"/240" Heavy Duty Square Wet Glaze Base Shoe for 1/2" Glass

- For 1/2" laminated tempered glass
- Base shoe only

Item #	Length	Pack
CBSAH120	120"	1 Pc.
CBSAH240	240"	1 Pc.



120" Straight Cladding for Heavy Duty Aluminum Square Base Shoe

- Adhere with cladding tape or silicone sealant
- 316 Stainless steel

Item #	Color	Pack
CBSCH120-BN	Brushed Nickel	1 Pc.
CBSCH120-MBL	Matte Black	1 Pc.



240" Straight Cladding for Heavy Duty Aluminum Square Base Shoe

- Adhere with cladding tape or silicone sealant
- 316 Stainless steel

Item #	Color	Pack
CBSCH240-BN	Brushed Nickel	1 Pc.
CBSCH240-MBL	Matte Black	1 Pc.



Wet Glaze Base Shoe Blocks (9 sets)

- Includes 9 sets of accessories for 120" base shoe

Item #	Pack
CBSAHACC02	9 Sets/Box



Black Rubber Gasket for CBSAH (2 pcs)

Item #	Pack
CBSAHP2	2 Pcs.



10" Square Surface Mount Post Clamp (Spigot)

- Includes gaskets for use with 3/8", 1/2" and 9/16" glass
- Attachment bolts sold separately
- Duplex 2205 stainless steel

Item #	Color	Pack
CWS09CP-CH	Chrome	1 Pc./Box
CWS09CP-BN	Brushed Nickel	1 Pc./Box
CWS09CP-MBL	Matte Black	1 Pc./Box



12" Tilt Lock Adjustable Fascia Mount Post Clamp (Spigot)

- For 1/2" - 11/16" thick glass
- Allows up to 2 degree of glass adjustment
- Duplex 2205 stainless steel

Item #	Color	Pack
CWS10CP-CH	Chrome	1 Pc./Box
CWS10CP-BN	Brushed Nickel	1 Pc./Box
CWS10CP-MBL	Matte Black	1 Pc./Box



6-3/8" Square Surface Mount Post Clamp (Spigot)

- Duplex 2205 stainless steel
- Height: 6 3/8"
- Friction fit suitable for 3/8"-1/2" (10mm-12mm) tempered glass

Item #	Color	Pack
CWS11CP-CH	Chrome	1 Pc./Box
CWS11CP-BN	Brushed Nickel	1 Pc./Box
CWS11CP-MBL	Matte Black	1 Pc./Box
CWS11CP-SB	Satin Brass	1 Pc./Box



6-3/8" Round Surface Mount Post Clamp (Spigot)

- Duplex 2205 stainless steel
- Height: 6 3/8"
- Friction fit suitable for 3/8"-1/2" (10mm-12mm) tempered glass

Item #	Color	Pack
CWS12CP-CH	Chrome	1 Pc./Box
CWS12CP-BN	Brushed Nickel	1 Pc./Box
CWS12CP-MBL	Matte Black	1 Pc./Box



6-3/16" Oval Base Top Mount Post Clamp (Spigot)

- For 3/8" - 1/2" thick glass
- Duplex 2205 stainless steel

Item #	Color	Pack
CWS13CP-CH	Chrome	1 Pc./Box
CWS13CP-BN	Brushed Nickel	1 Pc./Box
CWS13CP-MBL	Matte Black	1 Pc./Box



5-1/8" Edge Mount Post Clamp

- For 1/2" - 5/8" thick glass
- Allows up to 2 degree of glass adjustment

Item #	Color	Pack
CWS14CP-CH	Chrome	1 Pc./Box
CWS14CP-BN	Brushed Nickel	1 Pc./Box
CWS14CP-MBL	Matte Black	1 Pc./Box



1/2" Vertical Panel Clamp

- For use with 1/4", 3/8" and 1/2" panel
- To be used for vertical divider panels or shelving

Item #	Color	Pack
VGC38-CH	Chrome	1 Pc./Box
VGC38-BN	Brushed Nickel	1 Pc./Box
VGC38-MBL	Matte Black	1 Pc./Box



Glass Rail Standoff Base And Cap - 2" Diameter x 1-3/4" Projection

- For use with 1/2" & 3/4" (12 & 19mm) monolithic tempered glass or 9/16" and 27/32" (13.52 & 21.52mm) laminated tempered glass

Item #	Color	Pack
CSS11CP-CH	Chrome	1 Pc./Box
CSS11CP-BN	Brushed Nickel	1 Pc./Box
CSS11CP-MBL	Matte Black	1 Pc./Box



Glass Rail Standoff Base And Cap - 2" Diameter x 1" Projection

- For use with 1/2" & 3/4" (12 & 19mm) monolithic tempered glass or 9/16" and 27/32" (13.52 & 21.52mm) laminated tempered glass

Item #	Color	Pack
CSS13CP-CH	Chrome	1 Pc./Box
CSS13CP-BN	Brushed Nickel	1 Pc./Box
CSS13CP-MBL	Matte Black	1 Pc./Box



Glass Rail Square Standoff Base And Cap - 2" x 2" x 1" Projection

- For use with 1/2" - 13/16" thick glass

Item #	Color	Pack
CSS14CP-CH	Chrome	1 Pc./Box
CSS14CP-BN	Brushed Nickel	1 Pc./Box
CSS14CP-MBL	Matte Black	1 Pc./Box



Standard 2" Glass Rail Standoff Fitting with Mounting Plate

- 316 stainless steel
- Glass fabrication: two 3/4" (19mm) diameter hole per fitting

Item #	Color	Pack
CSS12CP-CH	Chrome	1 Pc./Box
CSS12CP-BN	Brushed Nickel	1 Pc./Box
CSS12CP-MBL	Matte Black	1 Pc./Box



Slot Mount Standoff

- For use with 1/2" glass

Item #	Color	Pack
CSS15CP-CH	Chrome	1 Pc./Box
CSS15CP-BN	Brushed Nickel	1 Pc./Box
CSS15CP-MBL	Matte Black	1 Pc./Box



Round Post Flange Cover

- Design to cover 1 1/4" pipe rail

Item #	Color	Pack
CRS11FG-CH	Chrome	1 Pc./Box
CRS11FG-BN	Brushed Nickel	1 Pc./Box
CRS11FG-MBL	Matte Black	1 Pc./Box

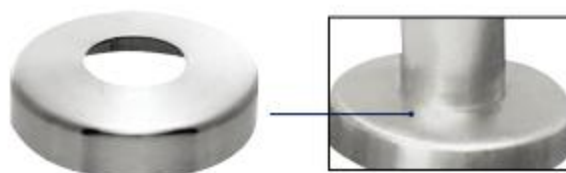

Square Post Flange Cover

- Design to cover 5" x 5" welded flanges on 2" outside diameter square tube
- 1" (25.4 mm) standard height

Item #	Color	Pack
CRS12FG-CH	Chrome	1 Pc./Box
CRS12FG-BN	Brushed Nickel	1 Pc./Box
CRS12FG-MBL	Matte Black	1 Pc./Box



2" Full Flange

- Full flange for 2" tubing

Item #	Color	Pack
CRS14FG-CH	Chrome	1 Pc./Box
CRS14FG-BN	Brushed Nickel	1 Pc./Box
CRS14FG-MBL	Matte Black	1 Pc./Box



Round 2" U-Shaped Flange

- Full flange for 2" tubing

Item #	Color	Pack
CRS17FG-CH	Chrome	1 Pc./Box
CRS17FG-BN	Brushed Nickel	1 Pc./Box
CRS17FG-MBL	Matte Black	1 Pc./Box



Square Flange

- Square full flange for 1 1/2" tubing

Item #	Color	Pack
CRS30FG-BN	Brushed Nickel	1 Pc./Box
CRS30FG-MBL	Brushed Nickel	1 Pc./Box



Flat End Cap

- Flat end cap for 2" round tube
- Required end caps and connector sleeves (sold separately)

Item #	Color	Pack
CRS13CAP-CH	Chrome	1 Pc.
CRS13CAP-BN	Brushed Nickel	1 Pc.
CRS13CAP-MBL	Matte Black	1 Pc.

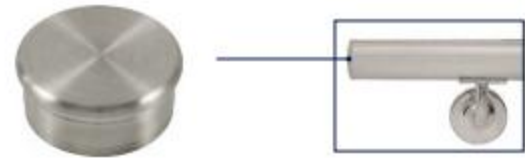

2" Round End Cap

- End cap for 2" cap railing

Item #	Color	Pack
CRS14CAP-CH	Chrome	1 Pc./Box
CRS14CAP-BN	Brushed Nickel	1 Pc./Box
CRS14CAP-MBL	Matte Black	1 Pc./Box

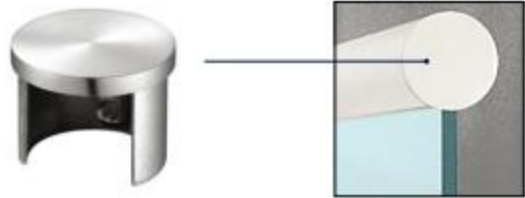

2" Dome End Cap

- Dome End cap for 2" cap railing

Item #	Color	Pack
CRS43CAP-CH	Chrome	1 Pc./Box
CRS43CAP-BN	Brushed Nickel	1 Pc./Box
CRS43CAP-MBL	Matte Black	1 Pc./Box



Square Flat End Cap

- Square end cap for 1 1/2" tubing

Item #	Color	Pack
CRS36CP-BN	Brushed Nickel	1 Pc./Box
CRS36CP-MBL	Matte Black	1 Pc./Box



1 1/2" Square Tubing - 120"

- 1 1/2" square tubing
- 120" long

Item #	Color	Pack
CRS12RL-120-CH	Chrome	1 Pc.
CRS12RL-120-BN	Brushed Nickel	1 Pc.
CRS12RL-120-MBL	Matte Black	1 Pc.



1 1/2" Square Tubing - 240"

- 1 1/2" square tubing
- 240" long

Item #	Color	Pack
CRS12RL-240-CH	Chrome	1 Pc./Box
CRS12RL-240-BN	Brushed Nickel	1 Pc./Box
CRS12RL-240-MBL	Matte Black	1 Pc./Box



2" 90 Degree Miter Corner

- Mitered style 90 degree corner for 2" tubing

Item #	Color	Pack
CRS25FT-CH	Chrome	1 Pc./Box
CRS25FT-BN	Brushed Nickel	1 Pc./Box
CRS25FT-MBL	Matte Black	1 Pc./Box



2" 90 Degree Flush Angle End

- 90 degree flush angle end for 2" tubing

Item #	Color	Pack
CRS26FT-CH	Chrome	1 Pc./Box
CRS26FT-BN	Brushed Nickel	1 Pc./Box
CRS26FT-MBL	Matte Black	1 Pc./Box



2" 180 Degree 2-Way Connector

- 180 degree 2-way connector for 2" tubing

Item #	Color	Pack
CRS12FT-CH	Chrome	1 Pc.
CRS12FT-BN	Brushed Nickel	1 Pc.
CRS12FT-MBL	Matte Black	1 Pc.



2" Adjustable Connector

- Adjustable connector for 2" tubing

Item #	Color	Pack
CRS33FT-CH	Chrome	1 Pc./Box
CRS33FT-BN	Brushed Nickel	1 Pc./Box
CRS33FT-MBL	Matte Black	1 Pc./Box



90 Degree Square Miter Corner

- 90 degree square miter corner for square tubing

Item #	Color	Pack
CRS31FT-BN	Brushed Nickel	1 Pc./Box
CRS31FT-MBL	Matte Black	1 Pc./Box



180 Degree Square 2-Way Connector

- 180 degree square 2-way connector for square tubing

Item #	Color	Pack
CRS32FT-BN	Brushed Nickel	1 Pc./Box
CRS32FT-MBL	Matte Black	1 Pc./Box



Square Flush Tee

- Square flush tee for square tubing

Item #	Color	Pack
CRS34FT-BN	Brushed Nickel	1 Pc./Box
CRS34FT-MBL	Matte Black	1 Pc./Box



90 Degree Square Side Outlet Elbow

- 90 degree square side outlet elbow for square tubing

Item #	Color	Pack
CRS35FT-BN	Brushed Nickel	1 Pc./Box
CRS35FT-MBL	Matte Black	1 Pc./Box



Rail Cap In-line Connector

- Connects to rail cap

Item #	Color	Pack
CRS27CT-CH	Chrome	1 Pc./Box
CRS27CT-BN	Brushed Nickel	1 Pc./Box
CRS27CT-MBL	Matte Black	1 Pc./Box



Rail Cap 90 Degree Connector

- Connects with rail cap

Item #	Color	Pack
CRS28CT-CH	Chrome	1 Pc./Box
CRS28CT-BN	Brushed Nickel	1 Pc./Box
CRS28CT-MBL	Matte Black	1 Pc./Box



2" Round Adjustable Downward Connector

- Adjustable down elbow
- 0-70 degrees

Item #	Color	Pack
CRS42CT-CH	Chrome	1 Pc./Box
CRS42CT-BN	Brushed Nickel	1 Pc./Box
CRS42CT-MBL	Matte Black	1 Pc./Box



1-1/2" Square Adjustable Downward Connector

- Adjustable down elbow
- 0-70 degrees

Item #	Color	Pack
CRS44CT-CH	Chrome	1 Pc./Box
CRS44CT-BN	Brushed Nickel	1 Pc./Box
CRS44CT-MBL	Matte Black	1 Pc./Box



Commercial Handrail Hardware

2" Extruded Cap Rail For 1/2" Glass - 120"

- Includes plastic insert

Item #	Color	Pack
CRS13CR-120-CH	Chrome	1 Pc.
CRS13CR-120-BN	Brushed Nickel	1 Pc.
CRS13CR-120-MBL	Matte Black	1 Pc.



2" Extruded Cap Rail For 1/2" Glass - 240"

- Includes plastic insert

Item #	Color	Pack
CRS13CR-240-CH	Chrome	1 Pc.
CRS13CR-240-BN	Brushed Nickel	1 Pc.
CRS13CR-240-MBL	Matte Black	1 Pc.



Flat Handrail Adapter Plate

- Adapter plate for flat handrail

Item #	Color	Pack
CRSADPT-01	Brushed Nickel	1 Pc./Box



Screws for Commercial Hardware

4" Hardwood Screw
for Surface Mount Post Clamp



CWSCPACC01

4" Flat Head Concrete Screw
for Surface Mount Post Clamp



CWSCPACC02

3" Hardwood Screw
for Surface Mount Post Clamp



CWSCPACC03

3" Wood Screw
for Standoff Base

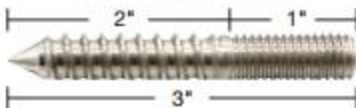

CSS11CPACC01

4" Wood Screw
for Standoff Base

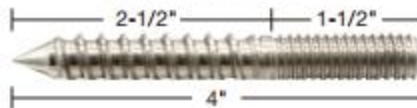

CSS11CPACC02

4" Round Head Concrete Screw
for Surface Mount Post Clamp



CSS-CA

3/8"-16 X 4" Socket Flat Head Wood Screws
for Standoff Base Shoe (9pcs)



CBSACC02

2" Tubing - 120"

- 2" diameter round .050" tubing
- 120" long

Item #	Color	Pack
CRS11RL-120-CH	Chrome	1 Pc.
CRS11RL-120-BN	Brushed Nickel	1 Pc.
CRS11RL-120-MBL	Matte Black	1 Pc.



2" Tubing - 240"

- 2" diameter round .050" tubing
- 120" long

Item #	Color	Pack
CRS11RL-240-CH	Chrome	1 Pc.
CRS11RL-240-BN	Brushed Nickel	1 Pc.
CRS11RL-240-MBL	Matte Black	1 Pc.



Glass Mount Hand Rail Bracket

- For 1 1/2", 1.9", or 2" (38, 48, or 51mm) diameter hand rail tubing
- For 1/2" to 1 1/16" (12 to 25.52mm) glass thickness

Item #	Color	Pack
CRS11BK-CH	Chrome	1 Pc./Box
CRS11BK-BN	Brushed Nickel	1 Pc./Box
CRS11BK-MBL	Matte Black	1 Pc./Box



Wall Mount Hand Rail Bracket

- For 1 1/2", 1.9", or 2" (38, 48, or 51mm) diameter hand rail tubing
- For 1/2" to 1 1/16" (12 to 25.52mm) glass thickness

Item #	Color	Pack
CRS12BK-CH	Chrome	1 Pc./Box
CRS12BK-BN	Brushed Nickel	1 Pc./Box
CRS12BK-MBL	Matte Black	1 Pc./Box



Long Arm Wall Bracket

- Hand railing bracket for 1.9" & 2" (48 & 51mm) tubing

Item #	Color	Pack
CRS15BK-CH	Chrome	1 Pc./Box
CRS15BK-BN	Brushed Nickel	1 Pc./Box
CRS15BK-MBL	Matte Black	1 Pc./Box



Concealed Surface Mount Hand Railing Bracket

- Concealed surface mount hand railing bracket for 1.9" & 2" (48 & 51mm) tubing

Item #	Color	Pack
CRS16BK-CH	Chrome	1 Pc./Box
CRS16BK-BN	Brushed Nickel	1 Pc./Box
CRS16BK-MBL	Matte Black	1 Pc./Box



2" Straight Saddle

- Straight saddle for 2" tubing

Item #	Color	Pack
CRS18SD-CH	Chrome	1 Pc./Box
CRS18SD-BN	Brushed Nickel	1 Pc./Box
CRS18SD-MBL	Matte Black	1 Pc./Box



2" Radius Adjustable Saddle

- Designed to attach to round style hand rails 1 1/2" to 2" (38 to 51mm) in diameter
- Includes mounting screws
- For 2" (51mm) diameter post

Item #	Color	Pack
CRS19SD-CH	Chrome	1 Pc./Box
CRS19SD-BN	Brushed Nickel	1 Pc./Box
CRS19SD-MBL	Matte Black	1 Pc./Box



Square Straight Saddle

- Straight saddle

Item #	Color	Pack
CRS37SD-BN	Brushed Nickel	1 Pc./Box



2" 90 Degree Side Outlet Elbow

- 90 degree side outlet elbow for 2" tubing

Item #	Color	Pack
CRS22FT-CH	Chrome	1 Pc./Box
CRS22FT-BN	Brushed Nickel	1 Pc./Box
CRS22FT-MBL	Matte Black	1 Pc./Box

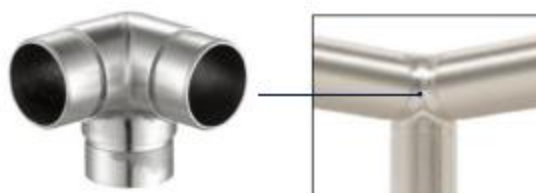

2" Flush Tee

- Flush tee for 2" tubing

Item #	Color	Pack
CRS23FT-CH	Chrome	1 Pc./Box
CRS23FT-BN	Brushed Nickel	1 Pc./Box
CRS23FT-MBL	Matte Black	1 Pc./Box



2" 135 Degree Flush Angle

- 135 Degree flush angle for 2" tubing

Item #	Color	Pack
CRS24FT-CH	Chrome	1 Pc./Box
CRS24FT-BN	Brushed Nickel	1 Pc./Box
CRS24FT-MBL	Matte Black	1 Pc./Box

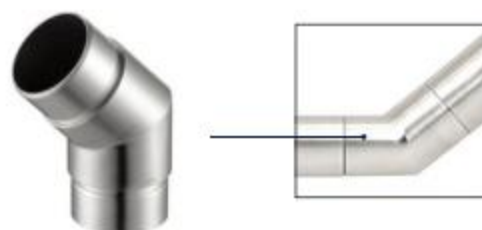

1-1/2" Height U Channel - 120"/240"

- 120"/240" long, 1-1/2" height U channel
- For 1/2" - 9/16" thick glass

Item #	Color	Pack
CUCN-1-1/2"-120/240-CH	Chrome	1 Pc.
CUCN-1-1/2"-120/240-BN	Brushed Nickel	1 Pc.
CUCN-1-1/2"-120/240-MBL	Matte Black	1 Pc.
CUCN-1-1/2"-120/240-SB	Satin Brass	1 Pc.
CUCN-1-1/2"-120/240-SA	Satin Anodized	1 Pc.



2" Height U Channel - 120"/240"

- 120"/240" long, 2" height U channel
- For 1/2" - 9/16" thick glass

Item #	Color	Pack
CUCN-2"-120/240-CH	Chrome	1 Pc.
CUCN-2"-120/240-BN	Brushed Nickel	1 Pc.
CUCN-2"-120/240-MBL	Matte Black	1 Pc.
CUCN-2"-120/240-SB	Satin Brass	1 Pc.
CUCN-2"-120/240-SA	Satin Anodized	1 Pc.



1-1/2" Deep End Cap for 120"/240" U Channel

- Covers open end of 1-1/2" deep U channel

Item #	Color	Pack
CUCN-1-EC-CH	Chrome	1 Pc.
CUCN-1-EC-BN	Brushed Nickel	1 Pc.
CUCN-1-EC-MBL	Matte Black	1 Pc.
CUCN-1-EC-SB	Satin Brass	1 Pc.



2" Deep End Cap for 120"/240" U Channel

- Covers open end of 2" deep U channel

Item #	Color	Pack
CUCN-2-EC-CH	Chrome	1 Pc.
CUCN-2-EC-BN	Brushed Nickel	1 Pc.
CUCN-2-EC-MBL	Matte Black	1 Pc.
CUCN-2-EC-SB	Satin Brass	1 Pc.



M4 Steel Cable

- Sold by foot

Item #	Color	Pack
CWR01RP-BN	Brushed Nickel	1 Pc./Box



M4 Wire Rope Lock

- Wire rope lock for steel cable

Item #	Color	Pack
CWR04LK	Brushed Nickel	1 Pc./Box



Wire Rope Post Clamp - 180 Degree

- 180 degree wire rope post clamp

Item #	Color	Pack
CWR02PT-BN	Brushed Nickel	1 Pc./Box
CWR02PT-MBL	Matte Black	1 Pc./Box



Wire Rope Post Clamp - 90 Degree

- 180 degree wire rope post clamp

Item #	Color	Pack
CWR03PT-BN	Brushed Nickel	1 Pc./Box
CWR03PT-MBL	Matte Black	1 Pc./Box



Bilateral Notched Post Clamp

- Available in 44" (overall)
- For 3/8" - 1/2" glass

Item #	Color	Pack
CNR01PT-44-BN	Brushed Nickel	1 Pc./Box
CNR01PT-44-MBL	Matte Black	1 Pc./Box

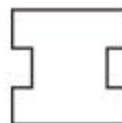

Single Notched Post Clamp

- Available in 44" (overall)
- For 3/8" - 1/2" glass

Item #	Color	Pack
CNR02PT-44-BN	Brushed Nickel	1 Pc./Box
CNR02PT-44-MBL	Matte Black	1 Pc./Box



90 Degree Bilateral Notched Post Clamp

- For 3/8" - 1/2" glass
- Available in 44" (overall)

Item #	Color	Pack
CNR03PT-44-BN	Brushed Nickel	1 Pc./Box
CNR03PT-44-MBL	Matte Black	1 Pc./Box



Single Sided End Post

- Single sided glass clamp post
- For 3/8" -1/2" clamps

Item #	Color	Pack
CRS39GC-BN	Brushed Nickel	1 Pc./Box
CRS39GC-MBL	Matte Black	1 Pc./Box



90 Degree Corner Post

- 90 degree glass clamp post
- For 3/8" -1/2" clamps

Item #	Color	Pack
CRS40GC-BN	Brushed Nickel	1 Pc./Box
CRS40GC-MBL	Matte Black	1 Pc./Box



Center Post

- 180 degree bilateral glass clamp post
- For 3/8" -1/2" clamps

Item #	Color	Pack
CRS41GC-BN	Brushed Nickel	1 Pc./Box
CRS41GC-MBL	Matte Black	1 Pc./Box



Round Glass Clamp End Post

- 42-3/4" total length
- For 3/8" -1/2" radius back clamps

Item #	Color	Pack
CRS39GCR-BN	Brushed Nickel	1 Pc./Box
CRS39GCR-MBL	Matte Black	1 Pc./Box



Round Glass Clamp 90 Degree Corner Post

- 42-3/4" total length
- For 3/8" -1/2" radius back clamps

Item #	Color	Pack
CRS40GCR-BN	Brushed Nickel	1 Pc./Box
CRS40GCR-MBL	Matte Black	1 Pc./Box



Round Glass Clamp Center Post

- 42-3/4" total length
- For 3/8" -1/2" radius back clamps

Item #	Color	Pack
CRS41GCR-BN	Brushed Nickel	1 Pc./Box
CRS41GCR-MBL	Matte Black	1 Pc./Box



Square Flat Base Glass Clamp

- 55 x 26mm
- For 3/8" - 1/2" glass

Item #	Color	Pack
CRS13CP-CH	Chrome	1 Pc./Box
CRS13CP-BN	Brushed Nickel	1 Pc./Box
CRS13CP-MBL	Matte Black	1 Pc./Box



Round Flat Base Glass Clamp

- 55 x 26mm
- For 3/8" - 1/2" glass

Item #	Color	Pack
CRS14CP-CH	Chrome	1 Pc./Box
CRS14CP-BN	Brushed Nickel	1 Pc./Box
CRS14CP-MBL	Matte Black	1 Pc./Box



Round Radius Base Glass Clamp

- 55 x 26mm
- For 3/8" - 1/2" glass

Item #	Color	Pack
CRS15CP-CH	Chrome	1 Pc./Box
CRS15CP-BN	Brushed Nickel	1 Pc./Box
CRS15CP-MBL	Matte Black	1 Pc./Box



Square 180 Degree Store Fronts Glass Clamp

- 180 degree square glass clamp for store fronts
- For 3/8" to 3/4" glass

Item #	Color	Pack
GCSF180-SQ-CH	Chrome	1 Pc./Box
GCSF180-SQ-BN	Brushed Nickel	1 Pc./Box
GCSF180-SQ-MBL	Matte Black	1 Pc./Box



Round 180 Degree Store Fronts Glass Clamp

- 180 degree round glass clamp for store fronts
- For 3/8" to 3/4" glass

Item #	Color	Pack
GCSF180-RD-CH	Chrome	1 Pc./Box
GCSF180-RD-BN	Brushed Nickel	1 Pc./Box
GCSF180-RD-MBL	Matte Black	1 Pc./Box



Square 90 Degree Store Fronts Glass Clamp

- 90 degree square glass clamp for store fronts
- For 3/8" to 1/2" glass

Item #	Color	Pack
GCSF90-SQ-CH	Chrome	1 Pc./Box
GCSF90-SQ-BN	Brushed Nickel	1 Pc./Box
GCSF90-SQ-MBL	Matte Black	1 Pc./Box



Square 135 Degree Store Fronts Glass Clamp

- 135 degree square glass clamp for store fronts
- For 3/8" to 1/2" glass

Item #	Color	Pack
GCSF135-SQ-CH	Chrome	1 Pc./Box
GCSF135-SQ-BN	Brushed Nickel	1 Pc./Box
GCSF135-SQ-MBL	Matte Black	1 Pc./Box



Square Store Fronts Wall Mount Glass Clamp

- Wall mount square glass clamp for store fronts
- For 3/8" to 1/2" glass

Item #	Color	Pack
GCSF-WM-SQ-CH	Chrome	1 Pc./Box
GCSF-WM-SQ-BN	Brushed Nickel	1 Pc./Box
GCSF-WM-SQ-MBL	Matte Black	1 Pc./Box



Wall Mount Glass Bracing Clamp

- Does not require holes in the glass
- Provide extra stability and rigidity for glass panels
- For 3/8" to 1/2" glass

Item #	Color	Pack
CWS15CP-CH	Chrome	1 Pc./Box
CWS15CP-BN	Brushed Nickel	1 Pc./Box
CWS15CP-MBL	Matte Black	1 Pc./Box



90 Degree Glass Bracing Clamp

- Does not require holes in the glass
- Provide extra stability and rigidity for glass panels
- For 3/8" to 1/2" glass

Item #	Color	Pack
CWS16CP-CH	Chrome	1 Pc./Box
CWS16CP-BN	Brushed Nickel	1 Pc./Box
CWS16CP-MBL	Matte Black	1 Pc./Box
CWS16CP-SB	Satin Brass	1 Pc./Box



180 Degree Glass Bracing Clamp

- Does not require holes in the glass
- Provide extra stability and rigidity for glass panels
- For 3/8" to 1/2" glass

Item #	Color	Pack
CWS17CP-CH	Chrome	1 Pc./Box
CWS17CP-BN	Brushed Nickel	1 Pc./Box
CWS17CP-MBL	Matte Black	1 Pc./Box
CWS17CP-SB	Satin Brass	1 Pc./Box



Adjustable Glass-to-Glass Bracing Clamp

- Does not require holes in the glass
- Provide extra stability and rigidity for glass panels
- For 3/8" to 1/2" glass

Item #	Color	Pack
CWS18CP-CH	Chrome	1 Pc./Box
CWS18CP-BN	Brushed Nickel	1 Pc./Box
CWS18CP-MBL	Matte Black	1 Pc./Box
CWS18CP-SB	Satin Brass	1 Pc./Box

180 DEGREE





Ladder Pull Back-To-Back Handle With Lock - 48"

- 36" CTC hole spacing, 48" total length
- Deadbolt locking mechanism

Item #	Color	Pack
CHLL48X48-CH	Chrome	1 Pc./Box
CHLL48X48-BN	Brushed Nickel	1 Pc./Box
CHLL48X48-MBL	Matte Black	1 Pc./Box



Ladder Pull Back-To-Back Handle With Lock - 60"

- 48" CTC hole spacing, 60" total length
- Deadbolt locking mechanism

Item #	Color	Pack
CHLL60X60-CH	Chrome	1 Pc./Box
CHLL60X60-BN	Brushed Nickel	1 Pc./Box
CHLL60X60-MBL	Matte Black	1 Pc./Box



24" Ladder Pull Back-to-Back Handle

- 12" CTC hole spacing, 24" total length
- For 5/16" to 1/2" (8 to 12 mm) glass

Item #	Color	Pack
CHLP24X24-NEW-CH	Chrome	1 Pc./Box
CHLP24X24-NEW-BN	Brushed Nickel	1 Pc./Box
CHLP24X24-NEW-MBL	Matte Black	1 Pc./Box



36" Ladder Pull Back-to-Back Handle

- 24" CTC hole spacing, 36" total length
- For 5/16" to 1/2" (8 to 12 mm) glass

Item #	Color	Pack
CHLP36X36-CH	Chrome	1 Pc./Box
CHLP36X36-BN	Brushed Nickel	1 Pc./Box
CHLP36X36-MBL	Matte Black	1 Pc./Box



48" Ladder Pull Back-to-Back Handle

- 36" CTC hole spacing, 48" total length

Item #	Color	Pack
CHLP48X48-CH	Chrome	1 Pc./Box
CHLP48X48-BN	Brushed Nickel	1 Pc./Box
CHLP48X48-MBL	Matte Black	1 Pc./Box



60" Ladder Pull Back-to-Back Handle

- 48" CTC hole spacing, 60" total length

Item #	Color	Pack
CHLP60X60-CH	Chrome	1 Pc./Box
CHLP60X60-BN	Brushed Nickel	1 Pc./Box
CHLP60X60-MBL	Matte Black	1 Pc./Box



72" Ladder Pull Back-to-Back Handle

- 60" CTC hole spacing, 72" total length

Item #	Color	Pack
CHLP72X72-CH	Chrome	1 Pc./Box
CHLP72X72-BN	Brushed Nickel	1 Pc./Box
CHLP72X72-MBL	Matte Black	1 Pc./Box



10" Offset Back-to-Back Pull Handle

- 10" CTC hole spacing

Item #	Color	Pack
CDH-10-OT-CH	Chrome	1 Pc./Box
CDH-10-OT-BN	Brushed Nickel	1 Pc./Box
CDH-10-OT-MBL	Matte Black	1 Pc./Box

Double Glass Door Lock

- Handles not included

Item #	Color	Pack
CDL-01-SET-CH	Chrome	1 Pc.
CDL-01-SET-BN	Brushed Nickel	1 Pc.
CDL-01-SET-MBL	Matte Black	1 Pc.



Aluminum Handle for Double Glass Door Lock

- Aluminum handle for CDL-01-SET

Item #	Color	Pack
CDL-02-HND-CH	Chrome	1 Set
CDL-02-HND-BN	Brushed Nickel	1 Set
CDL-02-HND-MBL	Matte Black	1 Set



Tubular Handle for Double Glass Door Lock

- Tubular style lever handle for CDL-01-SET

Item #	Color	Pack
CDL-03-HND-CH	Chrome	1 Set
CDL-03-HND-BN	Brushed Nickel	1 Set
CDL-03-HND-MBL	Matte Black	1 Set



Modern Style Handle for Double Glass Door Lock

- Modern style lever handle for CDL-01-SET

Item #	Color	Pack
CDL-04-HND-CH	Chrome	1 Set
CDL-04-HND-BN	Brushed Nickel	1 Set
CDL-04-HND-MBL	Matte Black	1 Set



Dual Horizontal Double Sided Door Lock

- Includes removal handles

Item #	Color	Pack
CDL-05-SET-CH	Chrome	1 Set
CDL-05-SET-BN	Brushed Nickel	1 Set
CDL-05-SET-MBL	Matte Black	1 Set



Dual Vertical Double Sided Door Lock

- Handles not included

Item #	Color	Pack
CDL-06-SET-CH	Chrome	1 Set
CDL-06-SET-BN	Brushed Nickel	1 Set
CDL-06-SET-MBL	Matte Black	1 Set



Tubular Style Handle for Vertical Double Sided Door Lock

- Tubular style lever handle for CDL-06-SET

Item #	Color	Pack
CDL-07-HND-CH	Chrome	1 Set
CDL-07-HND-BN	Brushed Nickel	1 Set
CDL-07-HND-MBL	Matte Black	1 Set



Modern Style Handle for Vertical Double Sided Door Lock

- Modern style lever handle for CDL-06-SET

Item #	Color	Pack
CDL-08-HND-CH	Chrome	1 Set
CDL-08-HND-BN	Brushed Nickel	1 Set
CDL-08-HND-MBL	Matte Black	1 Set



Smart Glass Door Lock

- Bluetooth smart lock with app and fingerprint function

Item #	Color	Pack
CDL-09-SL-CH	Chrome	1 Set
CDL-09-SL-BN	Brushed Nickel	1 Set
CDL-09-SL-MBL	Matte Black	1 Set



Double Door Lock with One Side Lock & One Side Knob

- Brass core with three brass keys

Item #	Color	Pack
CDL-10-DDL-CH	Chrome	1 Set
CDL-10-DDL-BN	Brushed Nickel	1 Set
CDL-10-DDL-MBL	Matte Black	1 Set



Double Door Lock with One Side Lock Only

- Brass core with three brass keys

Item #	Color	Pack
CDL-11-DDL-CH	Chrome	1 Set
CDL-11-DDL-BN	Brushed Nickel	1 Set
CDL-11-DDL-MBL	Matte Black	1 Set



Bottom Door Patch With 301 Insert

- For 3/8" or 1/2" (10 or 12 mm) tempered glass
- 2-3/4" (70 mm) pivot setback

Item #	Color	Pack
CP10-301-CH	Chrome	1 Pc./Box
CP10-301-BN	Brushed Nickel	1 Pc./Box
CP10-301-MBL	Matte Black	1 Pc./Box
CP10-301-SA	Satin Anodized	1 Pc./Box



Top Door Patch With 303 Insert

- For 3/8" or 1/2" (10 or 12 mm) tempered glass
- 2-3/4" (70 mm) pivot setback

Item #	Color	Pack
CP20-303-CH	Chrome	1 Pc./Box
CP20-303-BN	Brushed Nickel	1 Pc./Box
CP20-303-MBL	Matte Black	1 Pc./Box
CP20-303-SA	Satin Anodized	1 Pc./Box

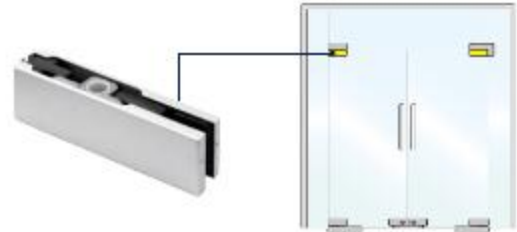

Top Door Patch With 304 Insert

- For 3/8" or 1/2" (10 or 12 mm) tempered glass
- For use with overhead concealed door closers

Item #	Color	Pack
CP20-304-CH	Chrome	1 Pc./Box
CP20-304-BN	Brushed Nickel	1 Pc./Box
CP20-304-MBL	Matte Black	1 Pc./Box
CP20-304-SA	Satin Anodized	1 Pc./Box

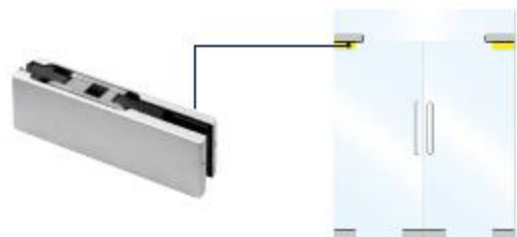

Wall Mounted Transom Patch With 300 Insert

- Works with both 2-3/4" and 2-9/16" (70 and 65 mm) pivot setback door patch fittings

Item #	Color	Pack
CP34-300-CH	Chrome	1 Pc./Box
CP34-300-BN	Brushed Nickel	1 Pc./Box
CP34-300-MBL	Matte Black	1 Pc./Box
CP34-300-SA	Satin Anodized	1 Pc./Box



Sidelite Transom Patch With 300 Insert

- For 3/8" or 1/2" (10 or 12 mm) glass
- Works with both 2-3/4" and 2-9/16" (70 and 65 mm) pivot setback door patch fittings

Item #	Color	Pack
CP40-300-CH	Chrome	1 Pc./Box
CP40-300-BN	Brushed Nickel	1 Pc./Box
CP40-300-MBL	Matte Black	1 Pc./Box
CP40-300-SA	Satin Anodized	1 Pc./Box



Commercial Door Patch Hardware

Sidelite Mounted Transom Patch with Reversible Door Stop

- For 3/8" or 1/2" (10 or 12 mm) Tempered Glass
- Doors Can Swing Either In or Out

Item #	Color	Pack
CP60-CH	Chrome	1 Pc./Box
CP60-BN	Brushed Nickel	1 Pc./Box
CP60-MBL	Matte Black	1 Pc./Box
CP60-SA	Satin Anodized	1 Pc./Box



Transom Mounted Connector With Two Reversible Door Stops

- For 3/8" or 1/2" (10 or 12 mm) Tempered Glass
- Both Doors Can Swing Either In or Out, or One Door Swing In and the Other Out

Item #	Color	Pack
CP70-CH	Chrome	1 Pc./Box
CP70-BN	Brushed Nickel	1 Pc./Box
CP70-MBL	Matte Black	1 Pc./Box
CP70-SA	Satin Anodized	1 Pc./Box



Patch Connector

- For 3/8" or 1/2" (10 or 12 mm) Tempered Glass

Item #	Color	Pack
CP80-CH	Chrome	1 Pc./Box
CP80-BN	Brushed Nickel	1 Pc./Box
CP80-MBL	Matte Black	1 Pc./Box
CP80-SA	Satin Anodized	1 Pc./Box



Patch Lock

- For 3/8" or 1/2" (10 or 12 mm) Tempered Glass

Item #	Color	Pack
CP205-CH	Chrome	1 Pc./Box
CP205-BN	Brushed Nickel	1 Pc./Box
CP205-MBL	Matte Black	1 Pc./Box
CP205-SA	Satin Anodized	1 Pc./Box



Top Center-Hung Free Swing Pivot

- Surface Mount Top Pivot Type for Use With Patch Fittings

Item #	Color	Pack
CP-401-BN	Brushed Nickel	1 Pc./Box
CP-401-MBL	Matte Black	1 Pc./Box



Adjustable Free-Swinging Bottom Pivot

- 3/16" (5 mm) of Height Adjustment
- Can Be Floor or Threshold Mounted

Item #	Color	Pack
CP-403-BN	Brushed Nickel	1 Pc./Box
CP-403-MBL	Matte Black	1 Pc./Box
CP-403-SA	Satin Anodized	1 Pc./Box



Office Partition Sliding Door System - OSD01

- Door width: 37 13/16" to 53 9/16"
- Door height: 98 7/16"
- Max. weight: 220lb.
- Available in chrome, brush nickel and matte black

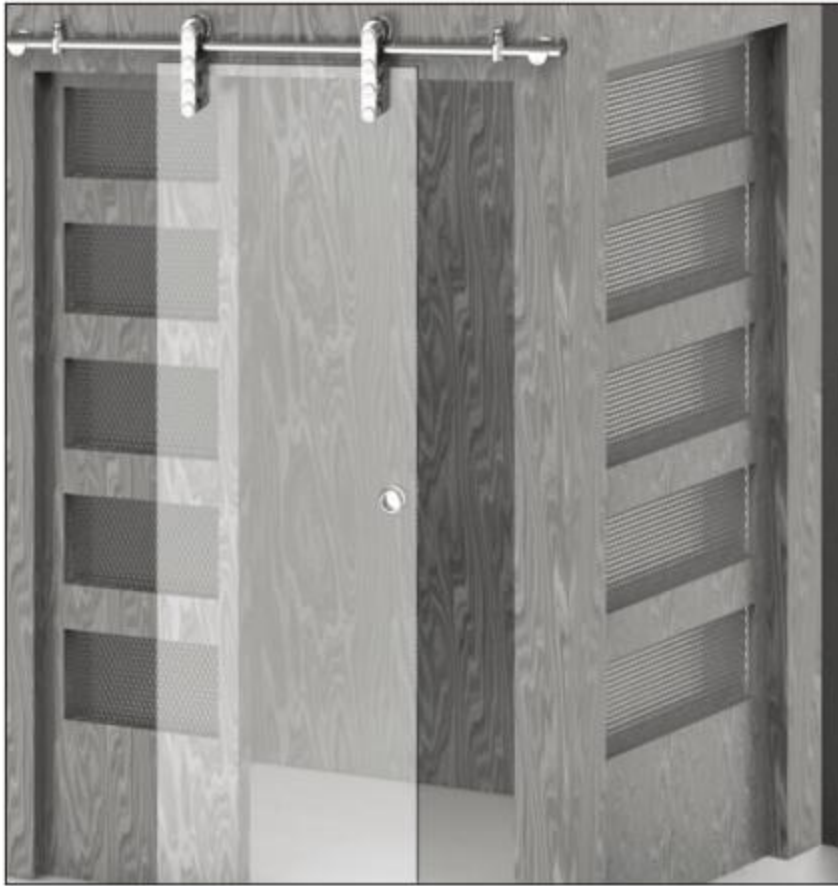

OSD01	Description	Quantity
	84" or 106" Tube	1
	Anti-lift top roller with flush and surface mount fitting	2
	Glass mount clamp	2
	Door stopper	2
	Floor guide	1
	Pull handle	1
	End cap	2

Commercial Door Hardware Sets

Office Partition Sliding Door System - CLOSD

- Anti-Lift top roller system

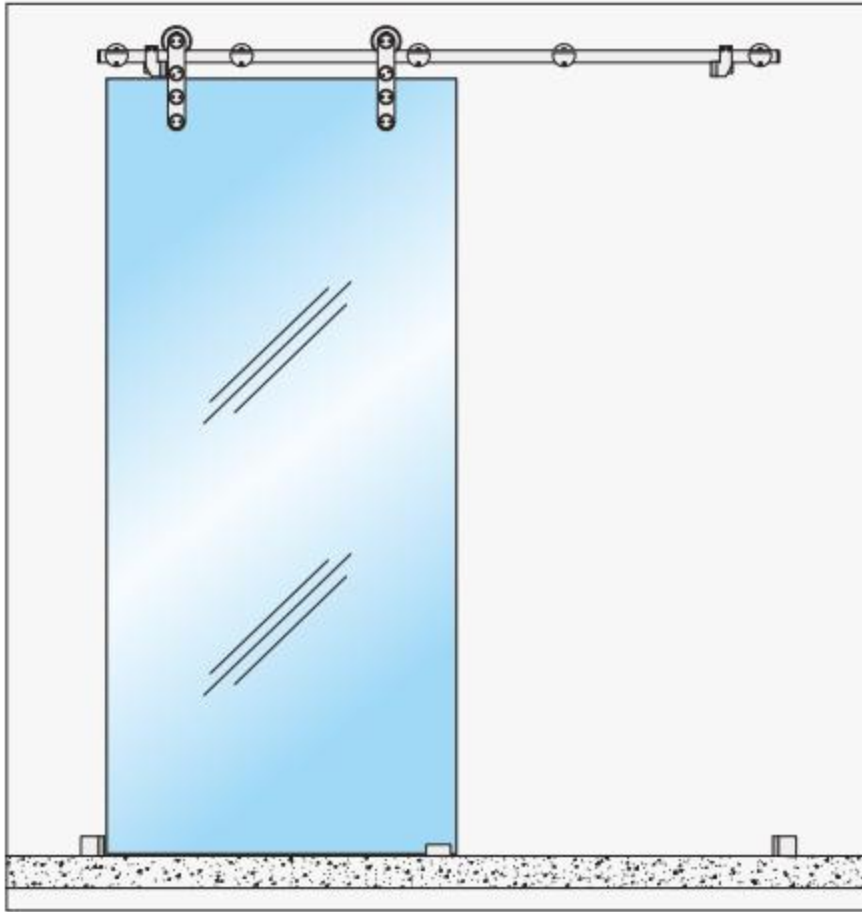







CLOSD	Description	Quantity
	Anti-Lift Top Roller	2
	Top Sliding Tube Glass Mount Clamp	5
	Left Hand Door Stop For Top Tube	1
	Right Hand Door Stop For Top Tube	1
	Adjustable Bottom Floor Guide	1
	End Cap For Dia25x2.5mm tube	2
	Tube Dia25xT2.0mm Length: 104" (2640mm)	1

Double Sliding Shower Door - UKD01

• Fits 48" - 72" opening



UKD01		Description	Quantity
UKD01HB		Header bar - Length: 48" - 98"	1
THLD-UKD01		Track holder	2
WMB-UKD01		Wall mount bracket	2
DRC01		Rubber cushion	4
ROL-UKD01		Roller - Diameter: 60mm	4
TBS20		20" Towel bar - With alternative thru-glass pull	1
FNP01		Pull handle	1
AJN-UKD01		Anti-jump nail	4
BG-UKD01		Bottom guide - Length: 2 3/4"	1
TH-L		Threshold	1
PSET-DS		Glass-to-Wall Sealing Strip	4
RPB-UKD01		Return panel bracket	1

Sliding Door Units

Single Sliding Shower Door - UKS04

• Fits 48" - 72" opening



UKS04		Description	Quantity
UKS04HB		Tubular header bar - Length: 48" - 120"	1
WMB-UKS04		Wall mount bracket	2
FPB-UKS04		Fixed panel bracket	2
DRC01		Rubber cushion	2
ROL-UKS04		Roller - diameter: 70mm	4
HLP12-UKS04		12" Ladder style pull handle	1
BG-UKS04/05		Bottom guide - Length: 2 3/4"	1
TH-L		Threshold	1
PSET-DS		Glass-to-Wall Sealing Strip	2
PFIN-84		90° FIN SEAL	1
GCS4		Square wall clamp	1
RPB-UKS04/05		Return panel bracket	1

Single Sliding Shower Door - UKS03

• Fits 48" - 72" opening



UKS03		Description	Quantity
UKS04HB		Header bar - Length: 48" - 120"	1
WMB-UKS04		Wall mount bracket	2
FPB-UKS04		Fixed panel bracket	2
DRC01		Rubber cushion	2
AJN-UKS05		Anti-jump nail	2
ROL-UKS04		Roller - diameter: 70mm	2
HLP12-UKS04		12" Ladder style pull handle	1
BG-UKS04/05		Bottom guide - Length: 2 3/4"	1
TH-L		Threshold	1
PSET-DS		Glass-to-Wall Sealing Strip	2
PFIN-84		90° FIN SEAL	1
GCS4		Square wall clamp	1
RPB-UKS04/05		Return panel bracket	1

Sliding Door Units

Single Sliding Shower Door - UKS05

• Fits 48" - 72" opening



UKS05		Description	Quantity
UKS05HB		Square Header bar - Length: 48" - 120"	1
WMB-UKS05		Wall mount bracket	2
FPB-UKS05		Fixed panel bracket	2
DRC01		Rubber cushion	2
ROL-UKS05		Roller - Diameter: 70mm	2
HSQ8X8		8" Pull handle	1
BG-UKS04/05		Bottom guide - Length: 2 3/4"	1
AJN-UKS05		Anti-jump nails	2
TH-L		Threshold	1
PSET-DS		Glass-To-Wall Sealing Strip	2
PFIN-84		90° FIN SEAL	1
GCS4		Square wall clamp	1
RPB-UKS04/05		Return panel bracket	1

Double Sliding Shower Door - UKD08

- Fits 60" opening













UKD08		Description	Quantity
UKD08HB		UKD08 Header Bar	1
SF-UKD08		Side Frame	2
BF-UKD08		Bottom Frame	1
ROL-UKD08		Roller For DS08	4
PC-UKD08		Plastic Cushion For UKD08	6
BG-UKD08		UKD08 Track Holder	1
HTB20UKD08		20" Towel bar For UKD08	1
KNB005S		Single Sided Cone Style Knob	1

Sliding Door Units

Double Sliding Shower Door - UKD06

- Fits 60" opening



UKD06		Description	Quantity
UKD06-HB		UKD06 Header Bar	1
SF-UKD06		Side Frame	2
BF-UKD06		Bottom Frame	1
ROL-UKD06		Wheels	4
CB-UKD06		Cushion Blocks (L & R)	4
PC-UKD06		Plastic Cushion for UKD06	4
BG-UKD06		Bottom Track Holder	1
SG-UKD06		Side Track Holder	2
HTB20DS06		20" Towel bar For UKD06	1
KNB006S		Finger Pull for UKD06	1

Single Sliding Shower Door - UKS09

- Fits 60" opening



UKS09		Description	Quantity
UKS09HB		Square header bar - Length: 48" - 72"	1
WMB-UKS09		Wall mount bracket	2
ROL-UKS09		Roller - Diameter: 40mm	2
DSP-UKS09		Door stopper	2
FPB-UKS09		Fixed panel bracket	2
AJN-UKS09		Anti-jump nails	2
BG-UKS09		Bottom guide - Length: 2-3/8"	1
FNP01		Pull handle	1
TH-L		Threshold	1
PSET-DS		Glass-To-Wall Sealing Strip	2
PFIN-84		90° FIN SEAL	1
GCS4		Square wall clamp	1

Photo Gallery





P-S&W-3/8-96

Swing Door Bottom Wipe or Vertical Seal for Bi-Fold Door - 96"

- For 3/8" Glass
- Length: 96" (hinge side)



P-S&W-1/2-96

Swing Door Bottom Wipe or Vertical Seal for Bi-Fold Door - 96"

- For 1/2" Glass
- Length: 96" (hinge side)



PBW-DR-32 / PBW-DR-3/8-96

Swing Door Bottom Wipe w/ 45" Drip Rail & 2 Vinyl Sweeps

- For 3/8" Glass
- Available in 32" / 96"



PBW-DR-1/2-96

Swing Door Bottom Wipe w/ 45" Drip Rail & 2 Vinyl Sweeps

- For 1/2" Glass
- Available in 96"



PDJ-L-84

Swing Door Multi-Purpose "L" Angle Jamb Seal for Both Hinge & Strike Jamb - 84"

- For 1/4" to 1/2" (6 to 12 mm) glass

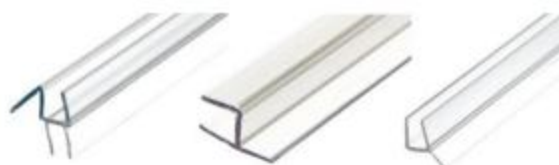

PSET-H07

Swing Door Combo Set

- Available in 76" / 80"



PSET-DS

Sliding Door Combo Set - 2 Glass-To-Wall Sealing Strips

- For UKD01
- Length: 76" / 84"

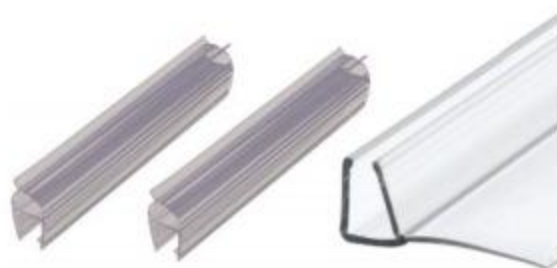

PSET-SS

Single Sliding Door Combo Set - 2 Glass-To-Wall Sealing Strips and 1 Gap Fin-Seal

- For UKS03/04/05
- Available in 76" / 84"



PDJ-180-3/8-96 / PDJ-180-1/2-96

Swing Door 180° Inline Door-To-Fixed Panel Door Strike Jamb w/Seal - 96"

- PDJ-180-3/8-96 For 3/8" Glass
- PDJ-180-1/2-96 For 1/2" Glass



PFIN-84

Single Sliding Door 90° Vinyl Fin-Seal - 84"

- For model UKS04/05/09
- For gap between door and fixed panel



PBW-Y-96

Bottom Rail With Wipe (CO-P500BR)

- Length: 96"



PDJ-MG-84

Swing Door 180° Inline Glass-To-Glass Magnetic Profile Seal - 84"

- For 3/8" to 1/2" (10 to 12 mm) glass



PDJ-90-96

Swing Door 90° Door-To-Fixed Panel Door Strike Jamb Seal

- "U" seal Polycarbonate strike and leg with 90 degree vinyl insert for 3/8" Glass
- Available in 96"



PBLB-84

Translucent Vinyl Bulb Seal

- For 3/8" Glass
- Length: 84"



PDJ-135-96

Swing Door 135° Door-To-Fixed Panel Door Strike Jamb Seal - 96"

- For 3/8" Glass
- Length: 96" (glass to glass)



TH-A-36

Acrylic Threshold - 36"

- Clear acrylic threshold
- 1/2" x 1/4" x 36"

Wall Mount H-Plate Standard Hinge

- Wall mount full back plate standard hinge
- 3/8" (10mm) to 1/2" (12mm) glass

Item #	Color	Pack
GIN037-CH	Chrome	1 Pc./Box
GIN037-BN	Brushed Nickel	1 Pc./Box
GIN037-MBL	Matte Black	1 Pc./Box
GIN037-SB	Satin Brass	1 Pc./Box
GIN037-GP	Gold Polished	1 Pc./Box
GIN037-SG	Space Gray	1 Pc./Box
GIN037-PC	Polished Copper	1 Pc./Box
GIN037-ABC	Antique Brush Copper	1 Pc./Box
GIN037-BBRZ	Brushed Bronze	1 Pc./Box
GIN037-PN	Polished Nickel	1 Pc./Box



Wall Mount Short H-Plate Standard Hinge

- Standard wall mount shot back plate hinge
- 3/8" (10mm) to 1/2" (12mm) glass

Item #	Color	Pack
GIN074-CH	Chrome	1 Pc./Box
GIN074-BN	Brushed Nickel	1 Pc./Box
GIN074-MBL	Matte Black	1 Pc./Box
GIN074-SB	Satin Brass	1 Pc./Box
GIN074-SG	Space Gray	1 Pc./Box
GIN074-BBRZ	Brushed Bronze	1 Pc./Box



Adjustable Wall Mount H-Plate Hinge

- Adjustable wall mount full back plate hinge
- Adjustable to any angle up to 90 degree without removing door
- 3/8" (10mm) to 1/2" (12mm) glass

Item #	Color	Pack
GIN337-CH	Chrome	1 Pc./Box
GIN337-BN	Brushed Nickel	1 Pc./Box
GIN337-MBL	Matte Black	1 Pc./Box
GIN337-SB	Satin Brass	1 Pc./Box
GIN337-BBRZ	Brushed Bronze	1 Pc./Box

ADJUSTABLE



Wall Mount H-Plate Standard Hinge - 5 Degree Offset

- Self-Centering with reversible 5 degree pivot pin
- 3/8" (10mm) to 1/2" (12mm) glass

Item #	Color	Pack
GIN537-CH	Chrome	1 Pc./Box
GIN537-BN	Brushed Nickel	1 Pc./Box
GIN537-MBL	Matte Black	1 Pc./Box
GIN537-SB	Satin Brass	1 Pc./Box
GIN537-GP	Gold Polished	1 Pc./Box



Wall Mount Short H-Plate Standard Hinge - 5 Degree Offset

- Short backplate shower hinge with black rubber gaskets with 5 degree offset
- 3/8" (10mm) to 1/2" (12mm) glass

Item #	Color	Pack
GIN574-CH	Chrome	1 Pc./Box
GIN574-BN	Brushed Nickel	1 Pc./Box
GIN574-MBL	Matte Black	1 Pc./Box



Wall Mount Offset Standard Hinge

- Shower hinge with offset plates with black rubber gaskets
- 3/8" (10mm) to 1/2" (12mm) glass

Item #	Color	Pack
GIN044-CH	Chrome	1 Pc./Box
GIN044-BN	Brushed Nickel	1 Pc./Box
GIN044-MBL	Matte Black	1 Pc./Box
GIN044-BBRZ	Brushed Bronze	1 Pc./Box



90 Degree Glass to Glass Standard Hinge

- 90 degree glass-to-glass standard hinge
- 3/8" (10mm) to 1/2" (12mm) glass

Item #	Color	Pack
GIN092-CH	Chrome	1 Pc./Box
GIN092-BN	Brushed Nickel	1 Pc./Box
GIN092-MBL	Matte Black	1 Pc./Box



Beveled Wall Mount H-Plate Hinge

- Wall mount full back H shape plate standard hinge
- 3/8" (10mm) to 1/2" (12mm) glass

Item #	Color	Pack
PIC037-CH	Chrome	1 Pc./Box
PIC037-BN	Brushed Nickel	1 Pc./Box
PIC037-MBL	Matte Black	1 Pc./Box
PIC037-SB	Satin Brass	1 Pc./Box
PIC037-SG	Space Gray	1 Pc./Box
PIC037-BBRZ	Brushed Bronze	1 Pc./Box



Beveled Wall Mount Short H-Plate Hinge

- Wall mount short back H shape plate standard hinge
- 3/8" (10mm) to 1/2" (12mm) glass

Item #	Color	Pack
PIC074-CH	Chrome	1 Pc./Box
PIC074-BN	Brushed Nickel	1 Pc./Box
PIC074-MBL	Matte Black	1 Pc./Box



Beveled Wall Mount H-Plate Hinge - 5 Degree Offset

- Self-Centering with reversible 5 degree pivot pin
- 3/8" (10mm) to 1/2" (12mm) glass

Item #	Color	Pack
PIC537-CH	Chrome	1 Pc./Box
PIC537-BN	Brushed Nickel	1 Pc./Box
PIC537-MBL	Matte Black	1 Pc./Box
PIC537-SB	Satin Brass	1 Pc./Box



135 Degree Glass to Glass Standard Hinge

- 135 degree glass-to-glass standard hinge with black rubber gaskets
- 3/8" (10mm) to 1/2" (12mm) glass

Item #	Color	Pack
GIN045-CH	Chrome	1 Pc./Box
GIN045-BN	Brushed Nickel	1 Pc./Box
GIN045-MBL	Matte Black	1 Pc./Box
GIN045-SB	Satin Brass	1 Pc./Box
GIN045-SG	Space Gray	1 Pc./Box



Adjustable 135 Degree Glass to Glass Standard Hinge

- Adjustable 135 degree glass-to-glass standard hinge
- 3/8" (10mm) to 1/2" (12mm) glass

Item #	Color	Pack
GIN345-CH	Chrome	1 Pc./Box
GIN345-BN	Brushed Nickel	1 Pc./Box
GIN345-MBL	Matte Black	1 Pc./Box
GIN345-SB	Satin Brass	1 Pc./Box
GIN345-SG	Space Gray	1 Pc./Box



180 Degree Glass to Glass Standard Hinge

- 180 degree glass-to-glass standard hinge
- 3/8" (10mm) to 1/2" (12mm) glass

Item #	Color	Pack
GIN180-CH	Chrome	1 Pc./Box
GIN180-BN	Brushed Nickel	1 Pc./Box
GIN180-MBL	Matte Black	1 Pc./Box
GIN180-SB	Satin Brass	1 Pc./Box
GIN180-SG	Space Gray	1 Pc./Box
GIN180-BBRZ	Brushed Bronze	1 Pc./Box
GIN180-PN	Polished Nickel	1 Pc./Box



Adjustable 180 Degree Glass to Glass Standard Hinge

- Adjustable 180 degree glass to glass standard hinge
- 3/8" (10mm) to 1/2" (12mm) glass

Item #	Color	Pack
GIN380-CH	Chrome	1 Pc.
GIN380-BN	Brushed Nickel	1 Pc.
GIN380-MBL	Matte Black	1 Pc.
GIN380-SB	Satin Brass	1 Pc.



Beveled 180 Degree Glass to Glass Standard Hinge

- 180 degree glass-to-glass standard hinge
- 3/8" (10mm) to 1/2" (12mm) glass

Item #	Color	Pack
PIC180-CH	Chrome	1 Pc./Box
PIC180-BN	Brushed Nickel	1 Pc./Box
PIC180-MBL	Matte Black	1 Pc./Box
PIC180-BBRZ	Brushed Bronze	1 Pc./Box



Heavy Duty Hinge

Top or Bottom Mount Pivot Hinge

- 3/8" (10mm) to 1/2" (12mm) glass

Item #	Color	Pack
PLK01-CH	Chrome	1 Pc./Box
PLK01-BN	Brushed Nickel	1 Pc./Box
PLK01-MBL	Matte Black	1 Pc./Box
PLK01-SB	Satin Brass	1 Pc./Box
PLK01-SG	Space Gray	1 Pc./Box



Heavy Duty Wall Mount H-Plate Hinge

- Heavy duty wall mount full back standard hinge
- 3/8" (10mm) to 1/2" (12mm) glass

Item #	Color	Pack
VAN037-CH	Chrome	1 Pc./Box
VAN037-BN	Brushed Nickel	1 Pc./Box
VAN037-MBL	Matte Black	1 Pc./Box
VAN037-SB	Satin Brass	1 Pc./Box
VAN037-SG	Space Gray	1 Pc./Box
VAN037-GP	Gold Polished	1 Pc./Box
VAN037-BBRZ	Brushed Bronze	1 Pc./Box
VAN037-PN	Polished Nickel	1 Pc./Box



Heavy Duty Short H-Plate Hinge

- Heavy duty wall mount short back plate standard hinge
- 3/8" (10mm) to 1/2" (12mm) glass

Item #	Color	Pack
VAN074-CH	Chrome	1 Pc./Box
VAN074-BN	Brushed Nickel	1 Pc./Box
VAN074-MBL	Matte Black	1 Pc./Box
VAN074-SB	Satin Brass	1 Pc./Box
VAN074-BBRZ	Brushed Bronze	1 Pc./Box



Heavy Duty Adjustable H-Plate Hinge

- Heavy duty adjustable wall mount full back plate hinge, adjustable to any angle up to 90 degree without removing door
- 3/8" (10mm) to 1/2" (12mm) glass

Item #	Color	Pack
VAN337-CH	Chrome	1 Pc./Box
VAN337-BN	Brushed Nickel	1 Pc./Box
VAN337-MBL	Matte Black	1 Pc./Box
VAN337-SB	Satin Brass	1 Pc./Box
VAN337-BBRZ	Brushed Bronze	1 Pc./Box

ADJUSTABLE



Heavy Duty Offset Short Back Plate Standard Hinge

- Heavy duty offset short back plate standard hinge
- 3/8" (10mm) to 1/2" (12mm) glass

Item #	Color	Pack
VAN040-CH	Chrome	1 Pc./Box
VAN040-BN	Brushed Nickel	1 Pc./Box
VAN040-MBL	Matte Black	1 Pc./Box
VAN040-SB	Satin Brass	1 Pc./Box



Heavy Duty Offset 90 Degree Hinge

- Shower hinge with offset plates with black rubber gaskets
- 3/8" (10mm) to 1/2" (12mm) glass

Item #	Color	Pack
VAN044-CH	Chrome	1 Pc./Box
VAN044-BN	Brushed Nickel	1 Pc./Box
VAN044-MBL	Matte Black	1 Pc./Box
VAN044-SB	Satin Brass	1 Pc./Box
VAN044-BBRZ	Brushed Bronze	1 Pc./Box



Heavy Duty Offset Standard Hinge

- 5 degree pre-set model (factory preset at 5 degree for tighter closure to shower interior)
- 3/8" (10mm) to 1/2" (12mm) glass

Item #	Color	Pack
VAN544-CH	Chrome	1 Pc./Box
VAN544-BN	Brushed Nickel	1 Pc./Box



Heavy Duty Wall Mount Beveled H-Plate Hinge

- Wall mount full back beveled heavy duty hinge with 5 degree offset
- 3/8" (10mm) to 1/2" (12mm) glass

Item #	Color	Pack
CHA037-CH	Chrome	1 Pc./Box
CHA037-BN	Brushed Nickel	1 Pc./Box
CHA037-MBL	Matte Black	1 Pc./Box
CHA037-SB	Satin Brass	1 Pc./Box
CHA037-SG	Space Gray	1 Pc./Box



Heavy Duty Wall Mount Beveled H-Plate Hinge - 5 Degree Offset

- Wall mount full back beveled heavy duty hinge with 5 degree offset
- 3/8" (10mm) to 1/2" (12mm) glass

Item #	Color	Pack
CHA537-CH	Chrome	1 Pc./Box
CHA537-BN	Brushed Nickel	1 Pc./Box
CHA537-MBL	Matte Black	1 Pc./Box



Heavy Duty 135 Degree Glass to Glass Hinge

- Heavy duty 135 degree glass-to-glass hinge
- 3/8" (10mm) to 1/2" (12mm) glass

Item #	Color	Pack
VAN045-CH	Chrome	1 Pc./Box
VAN045-BN	Brushed Nickel	1 Pc./Box
VAN045-MBL	Matte Black	1 Pc./Box
VAN045-SB	Satin Brass	1 Pc./Box
VAN045-SG	Space Gray	1 Pc./Box



Heavy Duty Hinges

Heavy Duty Adjustable 135 Degree Hinge

- Heavy duty 135 degree glass-to-glass hinge with internal 5 degree pin
- 3/8" (10mm) to 1/2" (12mm) glass

Item #	Color	Pack
VAN345-CH	Chrome	1 Pc./Box
VAN345-BN	Brushed Nickel	1 Pc./Box
VAN345-MBL	Matte Black	1 Pc./Box
VAN345-SB	Satin Brass	1 Pc./Box
VAN345-SG	Space Gray	1 Pc./Box

ADJUSTABLE



Heavy Duty Adjustable 135 Degree Beveled Hinge

- Heavy duty 135 degree glass-to-glass hinge with internal 5 degree pin
- 3/8" (10mm) to 1/2" (12mm) glass

Item #	Color	Pack
CHA345-CH	Chrome	1 Pc./Box
CHA345-BN	Brushed Nickel	1 Pc./Box
CHA345-MBL	Matte Black	1 Pc./Box

ADJUSTABLE



Heavy Duty 180 Degree Glass to Glass Hinge

- Heavy duty 180 degree glass-to-glass Standard Hinge
- 3/8" (10mm) to 1/2" (12mm) glass

Item #	Color	Pack
VAN180-CH	Chrome	1 Pc./Box
VAN180-BN	Brushed Nickel	1 Pc./Box
VAN180-MBL	Matte Black	1 Pc./Box
VAN180-SB	Satin Brass	1 Pc./Box
VAN180-SG	Space Gray	1 Pc./Box
VAN180-BBRZ	Brushed Bronze	1 Pc./Box
VAN180-PN	Polished Nickel	1 Pc./Box



Heavy Duty 180 Degree Glass to Glass Hinge

- Heavy duty 180 degree glass-to-glass Standard Hinge
- 3/8" (10mm) to 1/2" (12mm) glass

Item #	Color	Pack
VAN380-CH	Chrome	1 Pc./Box
VAN380-BN	Brushed Nickel	1 Pc./Box
VAN380-MBL	Matte Black	1 Pc./Box
VAN380-SB	Satin Brass	1 Pc./Box

ADJUSTABLE



Heavy Duty 180 Degree Glass to Glass Hinge - 5 Degree Offset

- Glass-to-glass hinge with internal 5 degree pin
- 3/8" (10mm) to 1/2" (12mm) glass

Item #	Color	Pack
VAN580-CH	Chrome	1 Pc./Box
VAN580-BN	Brushed Nickel	1 Pc./Box
VAN580-MBL	Matte Black	1 Pc./Box



Heavy Duty 180 Degree Glass-to-Glass Beveled Hinge

- Heavy Duty 180 Degree Glass-to-Glass Beveled Hinge
- 3/8" (10mm) to 1/2" (12mm) glass

Item #	Color	Pack
CHA180-CH	Chrome	1 Pc./Box
CHA180-BN	Brushed Nickel	1 Pc./Box
CHA180-MBL	Matte Black	1 Pc./Box



Heavy Duty Top or Bottom Mount Pivot Hinge

- For use with 1/2" (12 mm) glass

Item #	Color	Pack
PLKH02-CH	Chrome	1 Pc./Box
PLKH02-BN	Brushed Nickel	1 Pc./Box
PLKH02-MBL	Matte Black	1 Pc./Box
PLKH02-SB	Satin Brass	1 Pc./Box
PLKH02-SG	Space Gray	1 Pc./Box
PLKH02-BBRZ	Brushed Bronze	1 Pc./Box



Square Hole-In-Glass Fixed Panel U-Clamp

- 3/8" (10mm) to 1/2" (12mm) glass
- 5/8" or 3/4" (16 or 19mm) hole in panel (51x51x4mm)

Item #	Color	Pack
GCS4-CH	Chrome	1 Pc./Box
GCS4-BN	Brushed Nickel	1 Pc./Box
GCS4-MBL	Matte Black	1 Pc./Box
GCS4-SB	Satin Brass	1 Pc./Box
GCS4-SG	Space Gray	1 Pc./Box
GCS4-PC	Polished Copper	1 Pc./Box
GCS4-GP	Gold Plated	1 Pc./Box
GCS4-ABC	Antique Brush Copper	1 Pc./Box
GCS4-BBRZ	Brushed Bronze	1 Pc./Box
GCS4-PN	Polished Nickel	1 Pc./Box



Beveled Hole-In-Glass Fixed Panel U-Clamp

- 3/8" (10mm) to 1/2" (12mm) glass
- 5/8" or 3/4" (16 or 19mm) hole in panel (51x51x4mm)

Item #	Color	Pack
GCR4-CH	Chrome	1 Pc./Box
GCR4-BN	Brushed Nickel	1 Pc./Box
GCR4-MBL	Matte Black	1 Pc./Box
GCR4-SB	Satin Brass	1 Pc./Box
GCR4-SG	Space Gray	1 Pc./Box
GCR4-BBRZ	Brushed Bronze	1 Pc./Box

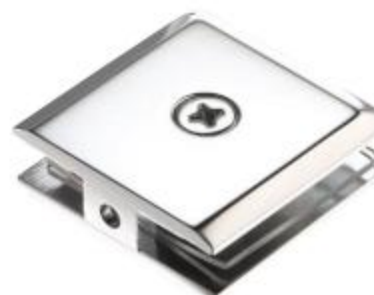

90 Degree Wall Mount Glass Clamp

- For 5/16" to 1/2" (8 to 12mm) glass (42x42x4mm)

Item #	Color	Pack
GCS039-CH	Chrome	1 Pc./Box
GCS039-BN	Brushed Nickel	1 Pc./Box
GCS039-MBL	Matte Black	1 Pc./Box
GCS039-SB	Satin Brass	1 Pc./Box



Square Wall Mount Movable Transom Clamp

- 3/8" (10mm) to 1/2" (12mm) glass
- Glass transom swivels to allow release of steam

Item #	Color	Pack
GCS186-CH	Chrome	1 Pc./Box
GCS186-BN	Brushed Nickel	1 Pc./Box
GCS186-MBL	Matte Black	1 Pc./Box
GCS186-SB	Satin Brass	1 Pc./Box



Square 180 Degree Glass-to-Glass Movable Transom Clamp

- 3/8" (10mm) to 1/2" (12mm) glass
- Glass transom swivels to allow release of steam

Item #	Color	Pack
GCS188-CH	Chrome	1 Pc./Box
GCS188-BN	Brushed Nickel	1 Pc./Box
GCS188-MBL	Matte Black	1 Pc./Box
GCS188-SB	Satin Brass	1 Pc./Box



180 Degree Glass to Glass Clamp

- For 5/16" to 1/2" (8 to 12mm) glass (42x42x4mm)
- 5/8" or 3/4" (16 or 19mm) hole in panel

Item #	Color	Pack
GCS180-CH	Chrome	1 Pc./Box
GCS180-BN	Brushed Nickel	1 Pc./Box
GCS180-MBL	Matte Black	1 Pc./Box



135 Degree Glass to Glass Clamp

- For 5/16" to 1/2" (8 to 12mm) glass (42x42x4mm)
- 5/8" or 3/4" (16 or 19mm) hole in panel

Item #	Color	Pack
GCS135-CH	Chrome	1 Pc./Box
GCS135-BN	Brushed Nickel	1 Pc./Box
GCS135-MBL	Matte Black	1 Pc./Box
GCS135-SB	Satin Brass	1 Pc./Box



90 Degree Glass to Glass Clamp

- For 3/8" to 1/2" (10 to 12 mm)

Item #	Color	Pack
GCS90TO90-CH	Chrome	1 Pc./Box
GCS90TO90-BN	Brushed Nickel	1 Pc./Box
GCS90TO90-MBL	Matte Black	1 Pc./Box
GCS90TO90-SB	Satin Brass	1 Pc./Box



90 Degree Open Face Glass to Glass Clamp

- For 3/8" to 1/2" (10 to 12 mm)

Item #	Color	Pack
GCSOF90-CH	Chrome	1 Pc./Box
GCSOF90-BN	Brushed Nickel	1 Pc./Box
GCSOF90-MBL	Matte Black	1 Pc./Box
GCSOF90-SB	Satin Brass	1 Pc./Box



Wall Mount Bracket

- For 5/16" to 1/2" (8 to 12mm) glass (42x42x4mm)

Item #	Color	Pack
GCS90S-CH	Chrome	1 Pc./Box
GCS90S-BN	Brushed Nickel	1 Pc./Box
GCS90S-MBL	Matte Black	1 Pc./Box
GCS90S-SB	Satin Brass	1 Pc./Box
GCS90S-SG	Space Gray	1 Pc./Box



Style Split Face and "Y" In-line Glass-to-Glass Clamp

- For 5/16" to 1/2" (8 to 12mm) glass (42x42x4mm)
- 5/8" or 3/4" (16 or 19mm) hole in panel

Item #	Color	Pack
GCR182-CH	Chrome	1 Pc./Box
GCR182-BN	Brushed Nickel	1 Pc./Box
GCR182-MBL	Matte Black	1 Pc./Box



Adjustable 90 Degree Wall Mount Glass Clamp

- For 5/16" to 1/2" (8 to 12 mm) glass (42x42x4mm)

Item #	Color	Pack
GCR037ADJ-CH	Chrome	1 Pc./Box
GCR037ADJ-BN	Brushed Nickel	1 Pc./Box
GCR037ADJ-MBL	Matte Black	1 Pc./Box



Glass End Support

- Fits dia. 25mm tube

Item #	Color	Pack
GES-UKS04-CH	Chrome	1 Pc./Box
GES-UKS04-BN	Brushed Nickel	1 Pc./Box
GES-UKS04-MBL	Matte Black	1 Pc./Box



Small Square Interior Shelf Clamp

- For 1/4" to 3/8" (6 to 10 mm) thick glass
- No glass fabrication required

Item #	Color	Pack
GCS10-CH	Chrome	1 Pc./Box
GCS10-BN	Brushed Nickel	1 Pc./Box
GCS10-MBL	Matte Black	1 Pc./Box



Adjustable Beveled Hold-In-Glass Fixed Panel U-Clamp (CO-SCU4-ADJ)

- For 1/4" to 3/8" (6 to 10 mm) thick glass
- Maximum 5" (127 mm) glass protrusion from wall is recommended.
- 5/8" or 3/4" (16 or 19mm) hole in panel (51x51x4mm), no cut

Item #	Color	Pack
GCS4NF-CH	Chrome	1 Pc./Box
GCS4NF-BN	Brushed Nickel	1 Pc./Box
GCS4NF-MBL	Matte Black	1 Pc./Box



Rectangular Interior Shower Shelf Clamp

- For 1/4" to 3/8" (6 to 10 mm) thick glass
- Maximum 5" (127 mm) glass protrusion from wall is recommended.

Item #	Color	Pack
GCS11-CH	Chrome	1 Pc./Box
GCS11-BN	Brushed Nickel	1 Pc./Box
GCS11-MBL	Matte Black	1 Pc./Box



Round Shelf Clamp

- For 1/4" to 3/8" (6 to 10 mm) thick glass
- Maximum 5" (127 mm) glass protrusion from wall is recommended.

Item #	Color	Pack
GCS12-CH	Chrome	1 Pc./Box
GCS12-BN	Brushed Nickel	1 Pc./Box
GCS12-MBL	Matte Black	1 Pc./Box



Heavy Duty Adjustable Shelf Clamp

- For 1/8" to 15/16" (3 to 24 mm) thick glass

Item #	Color	Pack
GCS661-CH	Chrome	1 Pc./Box
GCS661-BN	Brushed Nickel	1 Pc./Box
GCS661-MBL	Matte Black	1 Pc./Box



Heavy Duty Zinc Alloy Adjustable Rectangular Shelf Clamp

- For 1/8" to 1-1/8" (3 to 28 mm) thick glass
- Maximum 7-7/8" (200 mm) glass protrusion from wall is recommended.

Item #	Color	Pack
GCS163-CH	Chrome	1 Pc./Box
GCS163-BN	Brushed Nickel	1 Pc./Box
GCS163-MBL	Matte Black	1 Pc./Box



18" Steel Shelf Bracket

- Maximum 23-5/8" (600 mm) glass protrusion from wall is recommended.

Item #	Color	Pack
GCS18-MBL	Matte Black	2 Pcs./Box
GCS18-WT	White	2 Pcs./Box



90 Degree "Sleeve Over" Wall Mount Glass Clamp - Left

- For 5/16" to 1/2" (8 to 12mm) glass (42x42x4mm)

Item #	Color	Pack
SOC37L-CH	Chrome	1 Pc./Box
SOC37L-BN	Brushed Nickel	1 Pc./Box
SOC37L-MBL	Matte Black	1 Pc./Box
SOC37L-SG	Space Gray	1 Pc./Box
SOC37L-BBRZ	Brushed Bronze	1 Pc./Box



90 Degree "Sleeve Over" Wall Mount Glass Clamp - Right

- For 5/16" to 1/2" (8 to 12mm) glass (42x42x4mm)

Item #	Color	Pack
SOC37R-CH	Chrome	1 Pc./Box
SOC37R-BN	Brushed Nickel	1 Pc./Box
SOC37R-MBL	Matte Black	1 Pc./Box
SOC37R-SG	Space Gray	1 Pc./Box
SOC37R-BBRZ	Brushed Bronze	1 Pc./Box



90 Degree "Sleeve Over" Glass Clamp

- For 5/16" to 1/2" (8 to 12mm) glass (42x42x4mm)

Item #	Color	Pack
SOC90-CH	Chrome	1 Pc./Box
SOC90-BN	Brushed Nickel	1 Pc./Box
SOC90-MBL	Matte Black	1 Pc./Box
SOC90-SB	Satin Brass	1 Pc./Box
SOC90-SG	Space Gray	1 Pc./Box
SOC90-GP	Gold Polish	1 Pc./Box
SOC90-PC	Polished Copper	1 Pc./Box
SOC90-ABC	Antique Brush Copper	1 Pc./Box
SOC90-BBRZ	Brushed Bronze	1 Pc./Box
SOC90-PN	Polished Nickel	1 Pc./Box



135 Degree "Sleeve Over" Glass Clamp

- For 5/16" to 1/2" (8 to 12mm) glass (42x42x4mm)

Item #	Color	Pack
SOC135-CH	Chrome	1 Pc./Box
SOC135-BN	Brushed Nickel	1 Pc./Box
SOC135-MBL	Matte Black	1 Pc./Box



Adjustable 90 to 180 Degree Glass Shelf Clamp

- Adjustable from 90 to 180 degree
- For 5/16" to 1/2" (8 to 12mm) glass (42x42x4mm)

Item #	Color	Pack
SOC90ADJ-CH	Chrome	1 Pc./Box
SOC90ADJ-BN	Brushed Nickel	1 Pc./Box
SOC90ADJ-MBL	Matte Black	1 Pc./Box

ADJUSTABLE



Shower Door Header Accessories

Grand Series Shower Door Header Hardware Kit

- Includes one 98" header bar, one 36" door pocket filler, one pair of wall mounting bracket, and one clear vinyl

Item #	Color	Pack
GND-KD98-CH	Chrome	1 Pc./Box
GND-KD98-BN	Brushed Nickel	1 Pc./Box
GND-KD98-MBL	Matte Black	1 Pc./Box
GND-KD98-SB	Satin Brass	1 Pc./Box
GND-KD98-SG	Space Gray	1 Pc./Box
GND-KD98-GP	Gold Plated	1 Pc./Box



90 Degree Brass Adjustable Corner for the Grand Series Header Kit

- Connect and secure header pieces

Item #	Color	Pack
GND-CT90ADJ	Brass	1 Pc./Box



135 Degree Brass Fixed Corner for the Grand Series Header Kit

- Connect and secure header pieces

Item #	Color	Pack
GND-CT135	Brass	1 Pc./Box



Header Bar Bracket (Pair)

- Aluminum standard wall brackets
- Sold in pairs

Item #	Color	Pack
GND-CT01	Brass	2 Pcs./Box



Bright Anodized Adapter Block

Item #	Color	Pack
GND-CT02-CH	Chrome	1 Pc./Box
GND-CT02-BN	Brushed Nickel	1 Pc./Box
GND-CT02-MBL	Matte Black	1 Pc./Box
GND-CT02-SB	Satin Brass	1 Pc./Box



Adapter Block for PLKH02

Item #	Color	Pack
GND-CT03-CH	Chrome	1 Pc./Box
GND-CT03-BN	Brushed Nickel	1 Pc./Box
GND-CT03-MBL	Matte Black	1 Pc./Box
GND-CT03-SB	Satin Brass	1 Pc./Box



UKD01 Header Bar

- Available in 48", 55", 60", 65", 72", 84", and 98"

Item #	Color	Pack
UKD01HB-CH	Chrome	1 Pc.
UKD01HB-BN	Brushed Nickel	1 Pc.
UKD01HB-MBL	Matte Black	1 Pc.
UKD01HB-SB	Satin Brass	1 Pc.
UKD01HB-SG	Space Gray	1 Pc.



UKS04 Header Bar Without Hole

- Thickness: 3mm
- Available in 72", 84", 98", 106" and 120"

Item #	Color	Pack
UKS04HB-HN-CH	Chrome	1 Pc.
UKS04HB-HN-BN	Brushed Nickel	1 Pc.
UKS04HB-HN-MBL	Matte Black	1 Pc.
UKS04HB-HN-SB	Satin Brass	1 Pc.
UKS04HB-HN-SG	Space Gray	1 Pc.



UKS04 Header Bar With Hole

- Thickness: 3mm
- Available in 48", 55", 60", 65", and 72"

Item #	Color	Pack
UKS04HB-CH	Chrome	1 Pc.
UKS04HB-BN	Brushed Nickel	1 Pc.
UKS04HB-MBL	Matte Black	1 Pc.
UKS04HB-SB	Satin Brass	1 Pc.



UKS05 Header Bar Without Hole

- Thickness: 2.5mm
- Available in 72", 84", 98", 106" and 120"

Item #	Color	Pack
UKS05HB-NH-CH	Chrome	1 Pc./Box
UKS05HB-NH-BN	Brushed Nickel	1 Pc./Box
UKS05HB-NH-MBL	Matte Black	1 Pc./Box
UKS05HB-NH-SB	Satin Brass	1 Pc./Box



UKS05 Header Bar With Hole

- Thickness: 2.5mm
- Available in 48", 55", 60", 65", and 72"

Item #	Color	Pack
UKS05HB-CH	Chrome	1 Pc./Box
UKS05HB-BN	Brushed Nickel	1 Pc./Box
UKS05HB-MBL	Matte Black	1 Pc./Box



U Channel / J Channel / L Profile

U-Channel - 1/2"

- For 1/2" Glass, 3/4" (19mm) high profile deep U channel
- Provides support to shower enclosures without touching the ceiling

Item #	Color	Pack
UCN-1/2-98-CH	Chrome	1 Pc.
UCN-1/2-98-BN	Brushed Nickel	1 Pc.
UCN-1/2-98-MBL	Matte Black	1 Pc.
UCN-1/2-98-SB	Satin Brass	1 Pc.



U-Channel - 3/8"

- For 3/8" Glass, 3/4" (19mm) high profile deep U channel
- Provides support to shower enclosures without touching the ceiling

Item #	Color	Pack
UCN-3/8-98-CH	Chrome	1 Pc.
UCN-3/8-98-BN	Brushed Nickel	1 Pc.
UCN-3/8-98-MBL	Matte Black	1 Pc.
UCN-3/8-98-SB	Satin Brass	1 Pc.
UCN-3/8-98-SG	Space Gray	1 Pc.



J Channel for 1/4" Mirror (3/8 Depth) Face

- Length: 144"

Item #	Color	Pack
JCN-3/8-144-CH	Chrome	1 Pc.
JCN-3/8-144-BN	Brushed Nickel	1 Pc.
JCN-3/8-144-MBL	Matte Black	1 Pc.



J Channel for 1/4" Mirror (5/8 Depth) Face

- Length: 144"

Item #	Color	Pack
JCN-5/8-144-CH	Chrome	1 Pc.
JCN-5/8-144-BN	Brushed Nickel	1 Pc.
JCN-5/8-144-MBL	Matte Black	1 Pc.



1" L Profile Threshold - 98"

- Length: 98"
- 1" wide

Item #	Color	Pack
CTHLD-1-98-CH	Chrome	1 Pc./Box
CTHLD-1-98-BN	Brushed Nickel	1 Pc./Box
CTHLD-1-98-MBL	Matte Black	1 Pc./Box



1-1/2" L Profile Threshold - 98"

- Length: 98"
- 1-1/2" wide

Item #	Color	Pack
CTHLD-1 1/2-98-CH	Chrome	1 Pc./Box
CTHLD-1 1/2-98-BN	Brushed Nickel	1 Pc./Box
CTHLD-1 1/2-98-MBL	Matte Black	1 Pc./Box



36" Glass to Ceiling Round Support Bar

- Length: 36"
- For 3/8" to 1/2" thick glass

Item #	Color	Pack
SPB36CE-CH	Chrome	1 Pc./Box
SPB36CE-BN	Brushed Nickel	1 Pc./Box
SPB36CE-MBL	Matte Black	1 Pc./Box
SPB36CE-SB	Satin Brass	1 Pc./Box



Wall to Glass Round Support Bar

- 16" - 24" glass to wall brace
- For 3/8" to 1/2" thick glass

Item #	Color	Pack
SPB24ADJ-CH	Chrome	1 Pc./Box
SPB24ADJ-BN	Brushed Nickel	1 Pc./Box
SPB24ADJ-MBL	Matte Black	1 Pc./Box
SPB24ADJ-SB	Satin Brass	1 Pc./Box



24" Wall to Glass Square Support Bar - L Shaped

- 16" - 24" glass to wall brace
- For 3/8" glass only

Item #	Color	Pack
SPB24L-CH	Chrome	1 Pc./Box
SPB24L-BN	Brushed Nickel	1 Pc./Box
SPB24L-MBL	Matte Black	1 Pc./Box
SPB24L-SB	Satin Brass	1 Pc./Box



Wall to Glass Square Support Bar

- 47-1/4 length
- For 3/8" to 1/2" thick glass

Item #	Color	Pack
SPB49ADJ-CH	Chrome	1 Pc./Box
SPB49ADJ-BN	Brushed Nickel	1 Pc./Box
SPB49ADJ-MBL	Matte Black	1 Pc./Box
SPB49ADJ-SB	Satin Brass	1 Pc./Box
SPB49ADJ-SG	Space Gray	1 Pc./Box



Glass to Glass Square Support Bar

- 47-1/4 length
- For 3/8" to 1/2" thick glass

Item #	Color	Pack
SPB49ADJ02-CH	Chrome	1 Pc./Box
SPB49ADJ02-BN	Brushed Nickel	1 Pc./Box
SPB49ADJ02-MBL	Matte Black	1 Pc./Box
SPB49ADJ02-SB	Satin Brass	1 Pc./Box



6" x 6" Square Pull Handle

- For 1/4" to 1/2" (6 to 12 mm) glass
- No washers

Item #	Color	Pack
HSQ6X6-CH	Chrome	1 Pc./Box
HSQ6X6-BN	Brushed Nickel	1 Pc./Box
HSQ6X6-MBL	Matte Black	1 Pc./Box
HSQ6X6-SB	Satin Brass	1 Pc./Box



8" x 8" Square Pull Handle

- For 1/4" to 1/2" (6 to 12 mm) glass
- No washers

Item #	Color	Pack
HSQ8X8-CH	Chrome	1 Pc./Box
HSQ8X8-BN	Brushed Nickel	1 Pc./Box
HSQ8X8-MBL	Matte Black	1 Pc./Box
HSQ8X8-SB	Satin Brass	1 Pc./Box
HSQ8X8-SG	Space Gray	1 Pc./Box
HSQ8X8-BBRZ	Brushed Bronze	1 Pc./Box
HSQ8X8-PN	Polished Nickel	1 Pc./Box



6" x 6" Tubular Pull Handle with Metal Washers

- For 1/4"-1/2" glass
- 3/4" (19 mm) diameter

Item #	Color	Pack
HBM6X6-CH	Chrome	1 Pc./Box
HBM6X6-BN	Brushed Nickel	1 Pc./Box
HBM6X6-MBL	Matte Black	1 Pc./Box
HBM6X6-SB	Satin Brass	1 Pc./Box
HBM6X6-SG	Space Gray	1 Pc./Box
HBM6X6-BBRZ	Brushed Bronze	1 Pc./Box



8" x 8" Tubular Pull Handle with Metal Washers

- For 1/4"-1/2" glass
- 3/4" (19 mm) diameter

Item #	Color	Pack
HBM8X8-CH	Chrome	1 Pc./Box
HBM8X8-BN	Brushed Nickel	1 Pc./Box
HBM8X8-MBL	Matte Black	1 Pc./Box
HBM8X8-SB	Satin Brass	1 Pc./Box
HBM8X8-GP	Gold Plated	1 Pc./Box
HBM8X8-SG	Space Gray	1 Pc./Box
HBM8X8-PC	Polished Copper	1 Pc./Box
HBM8X8-ABC	Antique Brush Copper	1 Pc./Box
HBM8X8-BBRZ	Brushed Bronze	1 Pc./Box
HBM8X8-PN	Polished Nickel	1 Pc./Box



8" Round Mitered Corner Back-To-Back Pull Handle

- For 1/4" to 1/2" glass

Item #	Color	Pack
HMT8X8-CH	Chrome	1 Pc./Box
HMT8X8-BN	Brushed Nickel	1 Pc./Box
HMT8X8-MBL	Matte Black	1 Pc./Box
HMT8X8-SB	Satin Brass	1 Pc./Box



Square Single Sided Handle

- 8" CTC hole spacing
- For 1/4" to 1/2" glass
- Single sided door handle

Item #	Color	Pack
HSQ8-CH	Chrome	1 Pc./Box
HSQ8-BN	Brushed Nickel	1 Pc./Box
HSQ8-MBL	Matte Black	1 Pc./Box
HSQ8-SB	Satin Brass	1 Pc./Box



Square Single Sided Handle

- 12" CTC hole spacing
- For 1/4" to 1/2" glass
- Single sided door handle

Item #	Color	Pack
HSQ12-CH	Chrome	1 Pc./Box
HSQ12-BN	Brushed Nickel	1 Pc./Box
HSQ12-MBL	Matte Black	1 Pc./Box
HSQ12-SB	Satin Brass	1 Pc./Box



Tubular Single Sided Handle

- 8" CTC hole spacing
- For 1/4" to 1/2" glass
- Single sided door handle

Item #	Color	Pack
HBM8-CH	Chrome	1 Pc./Box
HBM8-BN	Brushed Nickel	1 Pc./Box
HBM8-MBL	Matte Black	1 Pc./Box



12" x 12" Tubular Ladder Style Pull Handle

- 8" CTC hole spacing.
- For 5/16" to 1/2" (8 to 12 mm) glass

Item #	Color	Pack
HLP8X8-CH	Chrome	1 Pc./Box
HLP8X8-BN	Brushed Nickel	1 Pc./Box
HLP8X8-MBL	Matte Black	1 Pc./Box
HLP8X8-SB	Satin Brass	1 Pc./Box
HLP8X8-SG	Space Gray	1 Pc./Box
HLP8X8-BBRZ	Brushed Bronze	1 Pc./Box



16" x 16" Tubular Ladder Style Pull Handle

- 12" CTC hole spacing.
- For 5/16" to 1/2" (8 to 12 mm) glass

Item #	Color	Pack
HLP12X12-CH	Chrome	1 Pc./Box
HLP12X12-BN	Brushed Nickel	1 Pc./Box
HLP12X12-MBL	Matte Black	1 Pc./Box
HLP12X12-SB	Satin Brass	1 Pc./Box



Towel Bars

20" Square Towel Bar

- Single sided towel bar
- 3/4" x 3/4"
- For 1/4" - 1/2" glass

Item #	Color	Pack
TBS20-CH	Chrome	1 Pc./Box
TBS20-BN	Brushed Nickel	1 Pc./Box
TBS20-MBL	Matte Black	1 Pc./Box
TBS20-SB	Satin Brass	1 Pc./Box
TBS20-SG	Space Gray	1 Pc./Box
TBS20-BBRZ	Brushed Bronze	1 Pc./Box



22" Square Towel Bar

- Single sided towel bar
- 3/4" x 3/4"
- For 1/4" - 1/2" glass

Item #	Color	Pack
TBS22-CH	Chrome	1 Pc./Box
TBS22-BN	Brushed Nickel	1 Pc./Box
TBS22-MBL	Matte Black	1 Pc./Box



24" Square Towel Bar

- Single sided towel bar
- 3/4" x 3/4"
- For 1/4" - 1/2" glass

Item #	Color	Pack
TBS24-CH	Chrome	1 Pc./Box
TBS24-BN	Brushed Nickel	1 Pc./Box
TBS24-MBL	Matte Black	1 Pc./Box
TBS24-SG	Space Gray	1 Pc./Box



18" Tubular Towel Bar with Metal Washer

- 3/4" diameter
- For 1/4" - 1/2" glass

Item #	Color	Pack
TBR18W-CH	Chrome	1 Pc./Box
TBR18W-BN	Brushed Nickel	1 Pc./Box
TBR18W-MBL	Matte Black	1 Pc./Box
TBR18W-SB	Satin Brass	1 Pc./Box



20" Tubular Towel Bar with Metal Washer

- 3/4" diameter
- For 1/4" - 1/2" glass

Item #	Color	Pack
TBR20W-CH	Chrome	1 Pc./Box
TBR20W-BN	Brushed Nickel	1 Pc./Box
TBR20W-MBL	Matte Black	1 Pc./Box
TBR20W-SB	Satin Brass	1 Pc./Box
TBR20W-BBRZ	Brushed Bronze	1 Pc./Box



22" Tubular Towel Bar with Metal Washer

- 3/4" diameter
- For 1/4" - 1/2" glass

Item #	Color	Pack
TBR22W-CH	Chrome	1 Pc./Box
TBR22W-BN	Brushed Nickel	1 Pc./Box
TBR22W-MBL	Matte Black	1 Pc./Box



24" Tubular Towel Bar with Metal Washer

- 3/4" diameter
- For 1/4" - 1/2" glass

Item #	Color	Pack
TBR24W-CH	Chrome	1 Pc./Box
TBR24W-BN	Brushed Nickel	1 Pc./Box
TBR24W-MBL	Matte Black	1 Pc./Box



24" Tubular Ladder Style Towel Bar

- 1" diameter x 24" long
- 20" CTC hole spacing
- For 1/4" - 1/2" glass

Item #	Color	Pack
TBL20-CH	Chrome	1 Pc./Box
TBL20-BN	Brushed Nickel	1 Pc./Box
TBL20-MBL	Matte Black	1 Pc./Box
TBL20-SB	Satin Brass	1 Pc./Box



18" Tubular Back-to-Back Tower Bar with Metal Washer

- 3/4" diameter
- For 1/4" - 1/2" glass

Item #	Color	Pack
HBM18X18-CH	Chrome	1 Pc./Box
HBM18X18-BN	Brushed Nickel	1 Pc./Box
HBM18X18-MBL	Matte Black	1 Pc./Box



6" x 18" Square Pull Handle/Towel Bar

- 3/4" x 3/4"
- For 1/4" - 1/2" glass

Item #	Color	Pack
HTS6X18-CH	Chrome	1 Pc./Box
HTS6X18-BN	Brushed Nickel	1 Pc./Box
HTS6X18-MBL	Matte Black	1 Pc./Box



Towel Bars

8" x 18" Square Pull Handle/Towel Bar

- 3/4" x 3/4"
- For 1/4" - 1/2" glass

Item #	Color	Pack
HTS8X18-CH	Chrome	1 Pc./Box
HTS8X18-BN	Brushed Nickel	1 Pc./Box
HTS8X18-MBL	Matte Black	1 Pc./Box
HTS8X18-SB	Satin Brass	1 Pc./Box



8" x 24" Square Pull Handle/Towel Bar

- 3/4" x 3/4"
- For 1/4" - 1/2" glass

Item #	Color	Pack
HTS8X24-CH	Chrome	1 Pc./Box
HTS8X24-BN	Brushed Nickel	1 Pc./Box
HTS8X24-MBL	Matte Black	1 Pc./Box
HTS8X24-SB	Satin Brass	1 Pc./Box
HTS8X24-BBRZ	Brushed Bronze	1 Pc./Box



6" x 18" Tubular Pull Handle/Towel Bar

- 3/4" diameter
- For 1/4" - 1/2" glass

Item #	Color	Pack
HTR6X18-CH	Chrome	1 Pc./Box
HTR6X18-BN	Brushed Nickel	1 Pc./Box
HTR6X18-MBL	Matte Black	1 Pc./Box



8" x 18" Tubular Pull Handle/Towel Bar

- 3/4" diameter
- For 1/4" - 1/2" glass

Item #	Color	Pack
HTR8X18-CH	Chrome	1 Pc./Box
HTR8X18-BN	Brushed Nickel	1 Pc./Box
HTR8X18-MBL	Matte Black	1 Pc./Box
HTR8X18-SB	Satin Brass	1 Pc./Box



8" x 24" Tubular Pull Handle/Towel Bar

- 3/4" diameter
- For 1/4" - 1/2" glass

Item #	Color	Pack
HTR8X24-CH	Chrome	1 Pc./Box
HTR8X24-BN	Brushed Nickel	1 Pc./Box
HTR8X24-MBL	Matte Black	1 Pc./Box
HTR8X24-SB	Satin Brass	1 Pc./Box
HTR8X24-BBRZ	Brushed Bronze	1 Pc./Box



Single Sided Door Knob

- Fits 1/4" to 1/2" (6 to 12 mm) thick glass
- 1/2" diameter hole in glass
- Solid brass material

Item #	Color	Pack
KNB001S-CH	Chrome	1 Pc./Box
KNB001S-BN	Brushed Nickel	1 Pc./Box
KNB001S-MBL	Matte Black	1 Pc./Box



Back-to-Back E-Z Grip Door Knob

- Fits 1/4" to 1/2" (6 to 12 mm) thick glass
- 1/2" diameter hole in glass
- Solid brass material

Item #	Color	Pack
KNB001D-CH	Chrome	1 Pc./Box
KNB001D-BN	Brushed Nickel	1 Pc./Box
KNB001D-MBL	Matte Black	1 Pc./Box



Cylinder Style Single Sided Door Knob

- Fits 1/4" to 1/2" (6 to 12 mm) thick glass
- 1/2" diameter hole in glass
- Solid brass material

Item #	Color	Pack
KNB002S-CH	Chrome	1 Pc./Box
KNB002S-BN	Brushed Nickel	1 Pc./Box
KNB002S-MBL	Matte Black	1 Pc./Box



Cylinder Style Back-to-Back Door Knob With Plastic Sleeve

- Fits 1/4" to 1/2" (6 to 12 mm) thick glass
- 1/2" diameter hole in glass
- Solid brass material

Item #	Color	Pack
KNB002D-CH	Chrome	1 Pc./Box
KNB002D-BN	Brushed Nickel	1 Pc./Box
KNB002D-MBL	Matte Black	1 Pc./Box



Traditional Style Single Sided Door Knob

- Fits 1/4" to 1/2" (6 to 12 mm) thick glass
- 1/2" diameter hole in glass
- Solid brass material

Item #	Color	Pack
KNB003S-CH	Chrome	1 Pc./Box
KNB003S-BN	Brushed Nickel	1 Pc./Box
KNB003S-MBL	Matte Black	1 Pc./Box



Traditional Style Back-to-Back Door Knob

- Fits 1/4" to 1/2" (6 to 12 mm) thick glass
- 1/2" diameter hole in glass
- Solid brass material

Item #	Color	Pack
KNB003D-CH	Chrome	1 Pc./Box
KNB003D-BN	Brushed Nickel	1 Pc./Box
KNB003D-MBL	Matte Black	1 Pc./Box



Contemporary Style Single Sided Door Knob

- Fits 1/4" to 1/2" (6 to 12 mm) thick glass
- 1/2" diameter hole in glass
- Solid brass material

Item #	Color	Pack
KNB004S-CH	Chrome	1 Pc./Box
KNB004S-BN	Brushed Nickel	1 Pc./Box
KNB004S-MBL	Matte Black	1 Pc./Box



Contemporary Style Back - to-Back Door Knob

- Fits 1/4" to 1/2" (6 to 12 mm) thick glass
- 1/2" diameter hole in glass
- Solid brass material

Item #	Color	Pack
KNB004D-CH	Chrome	1 Pc./Box
KNB004D-BN	Brushed Nickel	1 Pc./Box
KNB004D-MBL	Matte Black	1 Pc./Box



Cone Style Single Sided Door Knob

- Fits 1/4" to 1/2" (6 to 12 mm) thick glass
- 1/2" diameter hole in glass
- Solid brass material

Item #	Color	Pack
KNB005S-CH	Chrome	1 Pc./Box
KNB005S-BN	Brushed Nickel	1 Pc./Box
KNB005S-MBL	Matte Black	1 Pc./Box



Cone Style Back-to-Back Door Knob

- Fits 1/4" to 1/2" (6 to 12 mm) thick glass
- 1/2" diameter hole in glass
- Solid brass material

Item #	Color	Pack
KNB005D-CH	Chrome	1 Pc./Box
KNB005D-BN	Brushed Nickel	1 Pc./Box
KNB005D-MBL	Matte Black	1 Pc./Box



Single Sided Finger Pull for UKD06

- Fits 1/4" to 1/2" (6 to 12 mm) thick glass
- 1/2" diameter hole in glass
- Single sided finger pull for UKD06 glass
- 304 stainless steel

Item #	Color	Pack
KNB006S-CH	Chrome	1 Pc./Box
KNB006S-BN	Brushed Nickel	1 Pc./Box
KNB006S-MBL	Matte Black	1 Pc./Box



Sliding Door Thru-Glass Pull Handle

- Diameter: 58 mm
- For 5/16" to 3/8" (8 to 10 mm) glass

Item #	Color	Pack
FNP01-CH	Chrome	1 Pc./Box
FNP01-BN	Brushed Nickel	1 Pc./Box
FNP01-MBL	Matte Black	1 Pc./Box
FNP01-SB	Satin Brass	1 Pc./Box
FNP01-SG	Space Gray	1 Pc./Box



Floor Mounted Dome Style Door Stop

- Low profile base
- 1-3/4" heavy cast with vinyl insert

Item #	Color	Pack
CDS2501-CH	Chrome	1 Pc./Box
CDS2501-BN	Brushed Nickel	1 Pc./Box
CDS2501-MBL	Matte Black	1 Pc./Box



Sleeve-Over Robe Hook

- Mounts on top of 5/16" to 1/2" (8-12 mm) thick tempered glass
- Includes clear gaskets

Item #	Color	Pack
BRA-RH001-CH	Chrome	1 Pc./Box
BRA-RH001-BN	Brushed Nickel	1 Pc./Box
BRA-RH001-MBL	Matte Black	1 Pc./Box



Through Glass Robe Hook

- Adjusts for through glass mounting installation for 5/16" to 1/2" (8-12 mm) glass
- 1/2" diameter hole is required

Item #	Color	Pack
BRA-RH002-CH	Chrome	1 Pc./Box
BRA-RH002-BN	Brushed Nickel	1 Pc./Box
BRA-RH002-MBL	Matte Black	1 Pc./Box



CRL Tub and Shower Mildew Resistant Silicone



SLC-33SMRC

CRL Clear Dow Corning Glazing Sealant



SLC-DC1C

CRL Palmer Qwikset Mirror - Mastic



ADH-PM711N

CRL Surface Protector - 16 oz.



CNS-TPC16

Invisible Shield Nano - Scale Glass Coating



CNS-54215

Diamond Blue Repellent Wash



CNS-016

CRL 1973 Ammoniated Aerosol Glass Cleaner



CNS-1973

CRL Repel Cleaner & Protectant



CNS-17740

Diamond Luster Restoration Cream



CNS-017

Enduro Shield Glass Treatment Sample



CNS-ES-S01

8" Dia. Suction Cup Lifter - Metal Handle

- Strong suction to lift glass, marble, or tiles
- Red line safe indicator



Titanium Drill Bit

- Arrow point for precision and sharper starts
- U-shaped helix for faster chip removal
- Tri-flat shank for stronger chuck hold



15' X 1.5" RATCHET TIE DOWN W/J HOOK



15' X 1.5" RATCHET TIE DOWN W/PLATE HOOK



25' Compact Tape Measure



LINT FREE HEAVY DUTY GLASS WIPES (100)



1/16" x 2" Plastic Horseshoe Shims

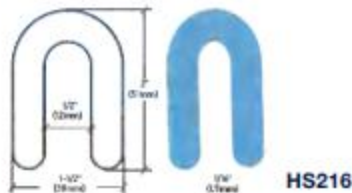

1/8" x 2" Plastic Horseshoe Shims

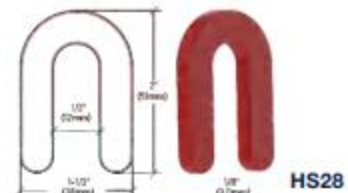

1/4" x 4" Plastic Horseshoe Shims

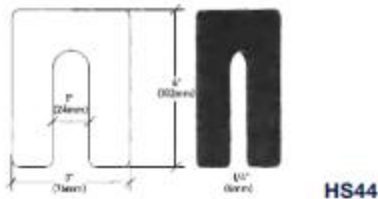

1/4" Square Beveled Clear Plastic Mirror Clip



WORK GLOVES - MEDIUM



UKWG300-M

WORK GLOVES - LARGE



UKWG300-L

.040" x 1/4" x 2" Clear Plastic Setting Blocks



UPSB040

.080" x 1/4" x 2" Clear Plastic Setting Blocks



UPSB080

1/8" x 1/4" x 2" Clear Plastic Setting Blocks



UPSB125

5/32" x 1/4" x 2" Clear Plastic Setting Blocks



UPSB156

1/4" x 1/4" x 2" Clear Plastic Setting Blocks



UPSB250

3/8" x 1/4" x 2" Clear Plastic Setting Blocks



UPSB375



LOS ANGELES

4610 Santa Anita Ave, El Monte, CA 91731 | 626.522.1551 | info@unikoogroup.com

ORANGE COUNTY

1820 S Santa Fe St, Santa Ana, CA 92705 | 888.404.5533 | infooc@unikoogroup.com

www.unikoogroup.com