



**SUNIKOO**  
GLASS & HARDWARE



# **UKS04**

## **THE KING SERIES**

### **INSTRUCTION MANUAL**

Scan for Installation Video



UKS04



UKS04RP



## TABLE OF CONTENT

### General instructions

Tools required .....	2
----------------------	---

### Combination chat

Combination chat .....	3
------------------------	---

### UKS04

UKS04 Parts Diagram .....	4
---------------------------	---

UKS04 Parts list .....	5
------------------------	---

UKS04 Section Diagram .....	7
-----------------------------	---

UKS04 Installation .....	8
--------------------------	---

### UKS04RP

UKHS04 Return Panel Parts Diagram .....	17
---	----

UKHS04 Return Panel Parts list .....	18
--------------------------------------	----

UKHS04 Return Panel Section Diagram .....	20
---	----

UKHS04 Return Panel Installation .....	21
--	----

### WARRANTY

Warranty .....	32
----------------	----

Other Models .....	35
--------------------	----

***Please keep this manual and the product code number for future reference and to order replacement parts if necessary***

### GENERAL INSTRUCTIONS

- Please read this manual carefully and thoroughly before proceeding.
- For your safety, it is recommended that you wear safety glasses at all times during installation.

### INSTALLATION OVER CERAMIC TILES

- If you are installing the shower door over ceramic tiles, make sure that the tiles lay completely under the wall jamb.
- Use mildew resistant silicone to seal the gaps where the ceramic tiles meet the fixed panel.









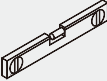

### NOTICE

- Caulking is not required inside the shower, unless otherwise stated.
- Some models are equipped with clear sealing gaskets.

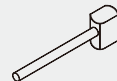
### CARE FOR YOUR SHOWER DOOR

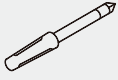
- Do not use scouring powder pads or sharp instruments on metal pieces or glass panels.
- To keep the panels and metal parts looking new, occasionally wipe them down with a mild soap diluted in water.
- We recommend wiping the glass panels with a squeegee after each use.

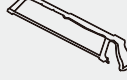
## TOOLS REQUIRED

 SPIRIT LEVEL	 POWER DRILL	 PENCIL	 SILICONE	 MALLET
 TAPE MEASURE	 SCREW DRIVER	 8mm (5/16") DRILL BITS	 HACKSAW	 SAFETY GLASSES

\* Use a 8mm(5/16") drill bit for ceramic when drilling into ceramic tiles.



**2 PEOPLE REQUIRED**

Product specifications are subject to change without notice.

## COMBINATION CHART

UKS04



**For bath tub model,  
please refer to step 6**

UKS04 Return panel



**Begin on Page 17**

## UKS04

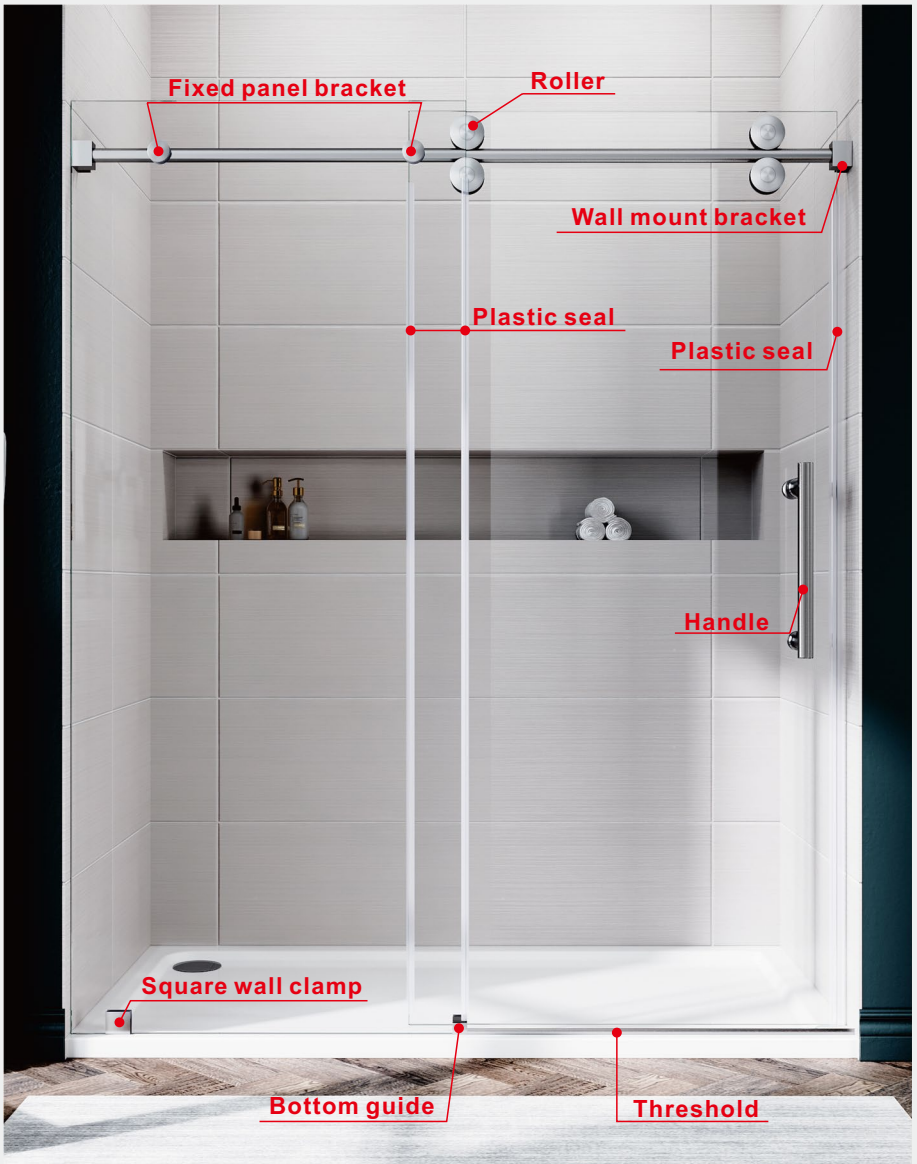

\*Our products are available in a variety of colors and sizes to suit your needs.

## PARTS LIST

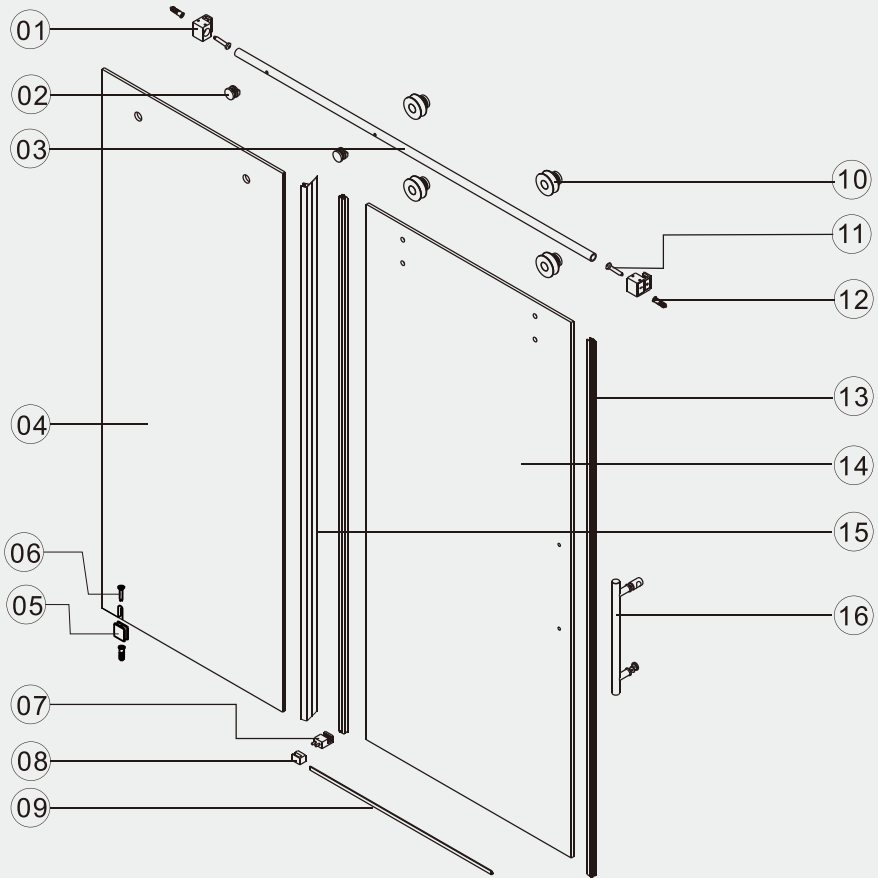

ITEM	PARTS	DIAGRAM	QTY	ITEM	PARTS	DIAGRAM	QTY
1	Wall mount bracket		2	9	Threshold		1
2	Fixed panel bracket		2	10	Ø70 Roller		4
3	Header bar		1	11	Screw St5x45		2
4	Fixed panel		1	12	Wall anchor Ø8		3
5	Square wall clamp		1	13	Door plastic seal		2
6	Screw St5x45		1	14	Sliding door		1
7	Bottom guide for door glass		1	15	Fixed panel plastic seal		1
8	Bottom guide for fixed glass		1	16	Handle		1

## PARTS LIST

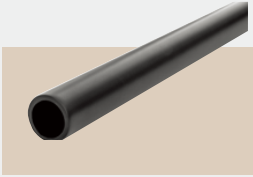

### ■ UKS04HB

Tubular Header Bar  
Length: 48"-98"  
304 Stainless Steel

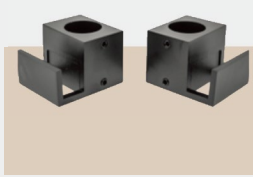

### ■ WMB-UKS04

Wall Mount Bracket  
304 Stainless Steel



### ■ FPB-UKS04

Fixed Panel Bracket  
304 Stainless Steel



### ■ DRC01

Rubber Cushion



### ■ TH-L

Aluminum Threshold



### ■ GCS4

Solid Brass  
Square Wall Clamp



### ■ ROL-UKS04

Roller - Diameter: 70mm  
304 Stainless Steel



### ■ HLP12-UKS04

12" Pull Handle  
304 Stainless Steel



### ■ BG-UKS04/05

Bottom Guide  
Length: 2-3/4"  
304/316 Stainless Steel

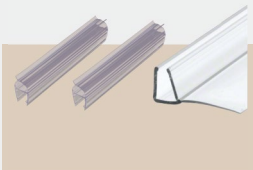

### ■ PSET-SS

2 Glass-To-Wall Sealing  
Strip and 1 Gap Fin-Seal

# SECTION DIAGRAM

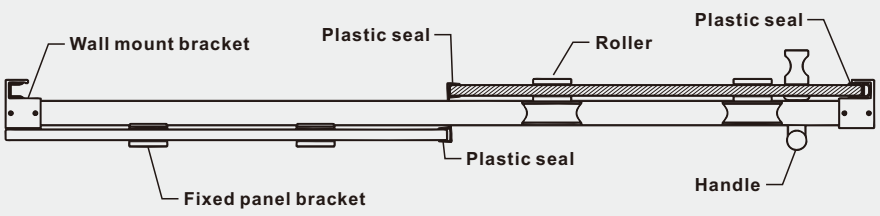
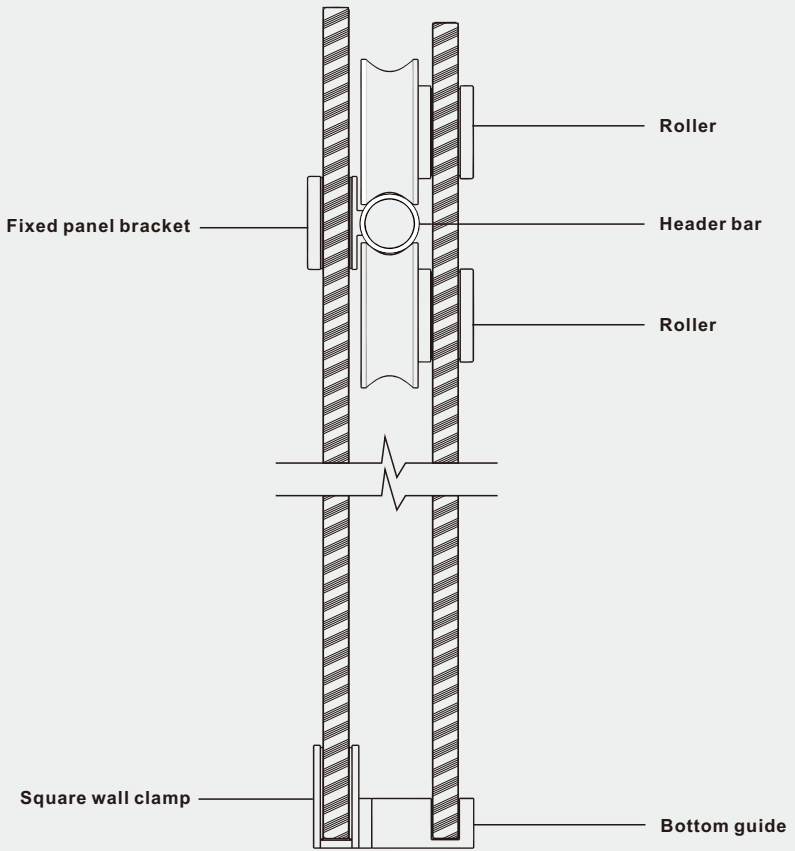



**Left**



**Right**

\*Before starting the installation, decide whether to install the door on the left or right side based on the specific conditions at the site.

### UKS04 DRILLING GUIDE

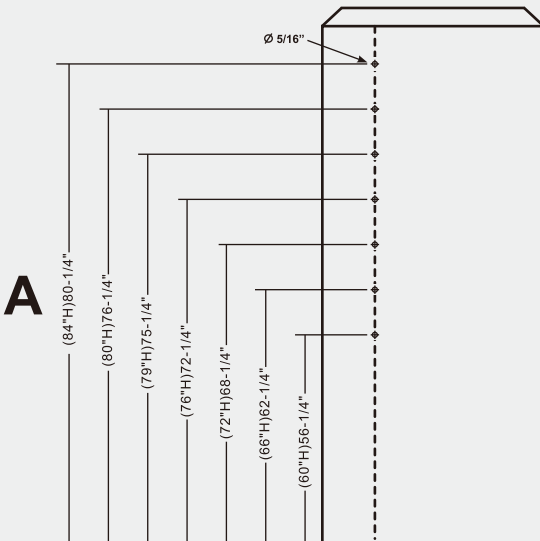

Product Height"	Header Bar Height"(A)
60"	56-1/4"
66"	62-1/4"
72"	68-1/4"
76"	72-1/4"
79"	75-1/4"
80"	76-1/4"
84"	80-1/4"

#### ATTENTION

Please verify the measurements with a tape measure before drilling any holes in the wall.

# STEP 1

## Installation of the top header

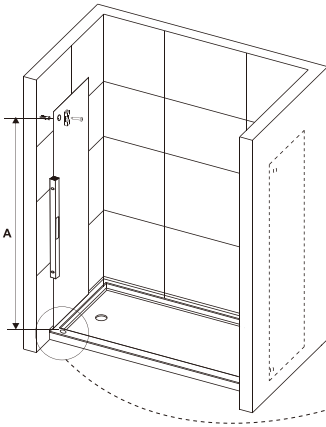

Product Height"	Header Bar Height"(A)	Product Height"	Header Bar Height"(A)
60"	56-1/4"	79"	75-1/4"
66"	62-1/4"	80"	76-1/4"
72"	68-1/4"	84"	80-1/4"
76"	72-1/4"		

\*Please verify the measurements with a tape measure before drilling any holes in the wall.

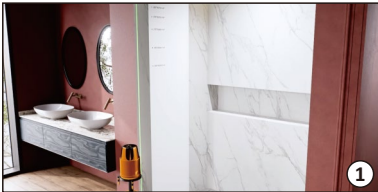
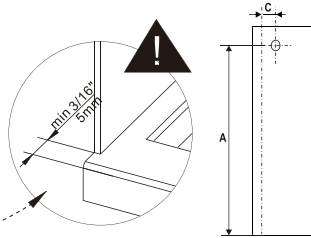

1 \*Use a spirit level or laser level to measure the wall. Once aligned horizontally, attach the height template to both sides of the wall.



2 \*Mark these locations with a pen, ensuring precision and clarity for accurate positioning during subsequent drilling. Be sure to double check hole location with measuring tape before drilling.

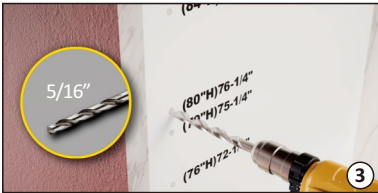

3 \*Select the appropriate hole positions according to the height of the shower door you purchased. Drill the holes using a 5/16" drill bit.



4 \*Insert wall anchors into the drilled holes.



5 \*Use an Allen wrench to remove the wall mount bracket covers.

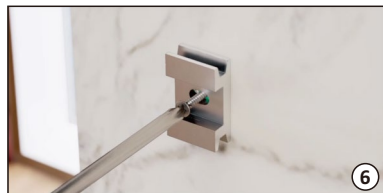

6 \*Align the brackets with the holes and securely tighten them with screws.

## STEP 2

### Installation of the top header

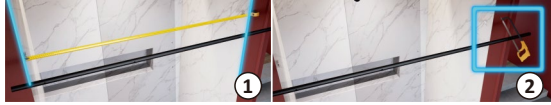
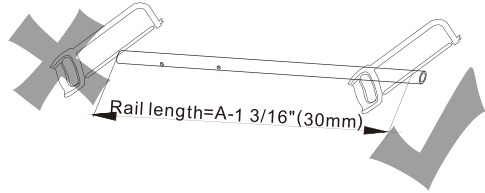
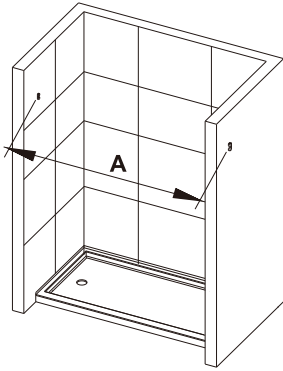

\*Measure the desired length and use a saw to accurately cut the stainless steel header bar, ensuring that the edges are smooth and flat.

\*When cutting the stainless steel header bar, make the cut on the side without holes to allow for adjustment.

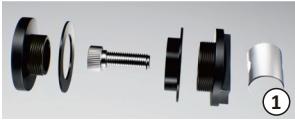

\*Disassemble the glass fixing fittings.

\*Insert the cylinder fixing blocks into the stainless steel header bar, ensuring that the holes align with the pre-drilled holes on the header bar. Then, arrange the fittings in order and secure them with screws.

## STEP 3

### Installation of the top header

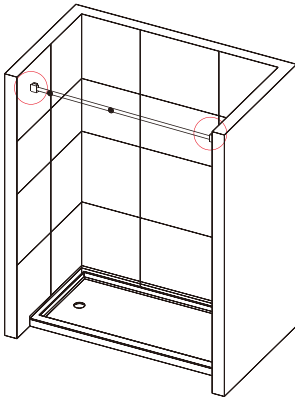

\*Insert the two wall mount bracket covers into the rails. Align them with the installed wall mount brackets and push them securely into place.

\*Use an Allen wrench to securely tighten the screws on both sides of the covers.

## STEP 4

### Installation of the glass door rollers

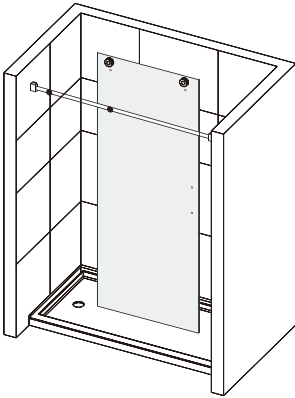

\*Place the rollers in the correct order on the holes in the glass door, after tightening the rollers using the screws and placing the inner glass inside. Please use a mat or soft cloth on the placement area to protect the door and the floor.

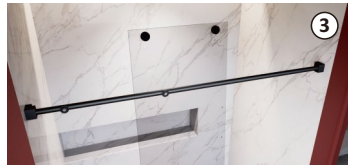
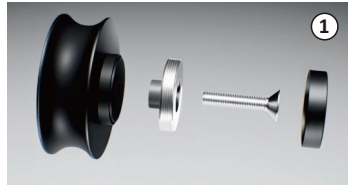

## STEP 5

### Installation of fixed panel and square wall clamp

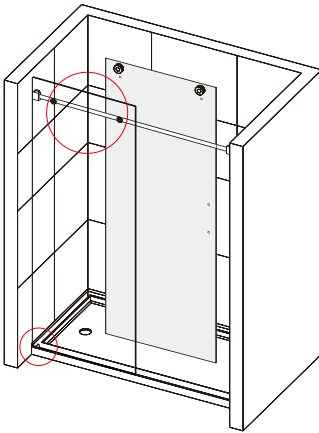

\*Secure the glass to the track first to ensure accurate installation of the bottom guide.

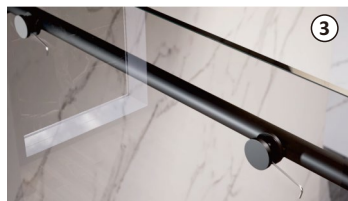
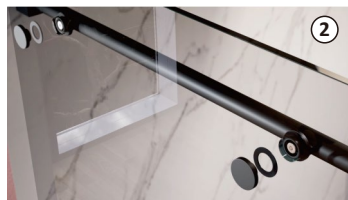

## STEP 6

### Installation of fixed panel and square wall clamp

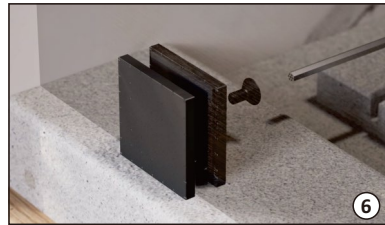
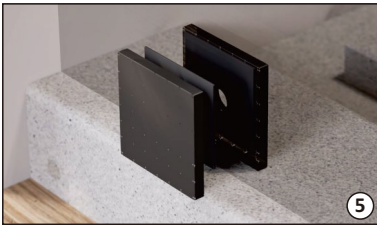
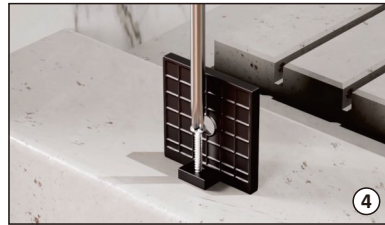
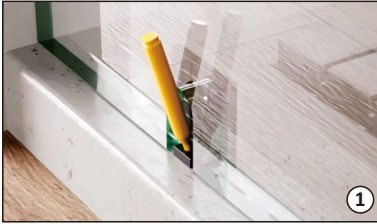

\*Use a level to ensure the glass is vertically aligned, and mark the positions of the glass clamping holes with a marker.

\*Loosen the covers, remove the glass from the track, and place it in a safe location.

\*Use a 5/16-inch drill bit to drill 5/16-inch holes.

\*Insert anchors into the ground, align the clamps with the holes. Tighten them with screws, and then install the glass gasket.

\*Align the glass-holding holes with the header bar fixed panel brackets. Install the spacers, and securely tighten the knobs using an Allen wrench.

\*At the bottom, install the gasket and cover, then securely tighten the screws from the inside using an Allen wrench.

#### WARNING



When purchasing a bathtub shower enclosure model, please install the glass clamp securely on the wall.

## STEP 7

### Installation of bottom guide

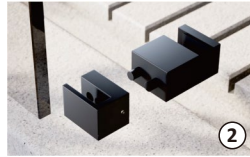
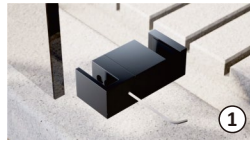
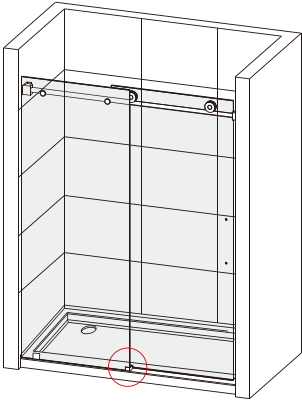

- \*Remove the bottom guide, snap the left-side piece onto the glass first, and then tighten the side screws.
- \*When installing the glass on sliding rail, ensure both wheels are securely seated and glide smoothly along the rail for safe operation.
- \*Ensure the glass snaps securely into place against the bottom guide, then push it in and tighten the screws to secure its position.

## STEP 8

### The correct method of installing glass

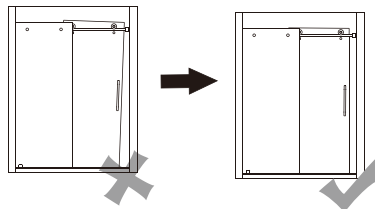
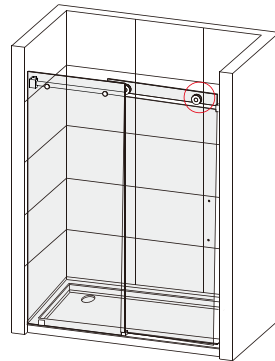
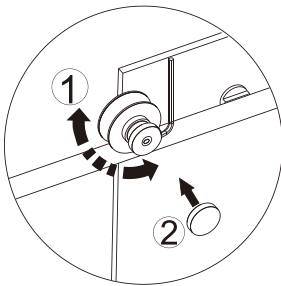

- \*If you notice that the glass is not level at the top and bottom, adjust the eccentric screw on the wheels to ensure the glass is level.

## STEP 9

### Installation of the glass door rollers

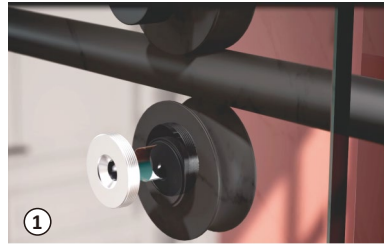
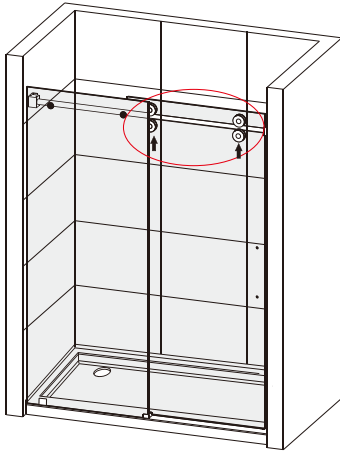

\*Once you've verified that the sliding glass door is level, adjust the bottom wheels to ensure they make contact with the track, preventing the glass from falling and reducing the risk of injury.

## STEP 10

### Installation of the water stopper in the bottom fixture recess

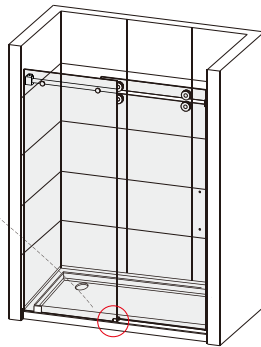
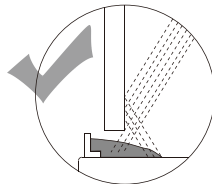
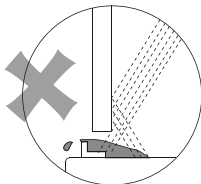
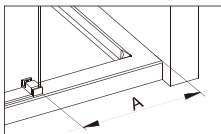
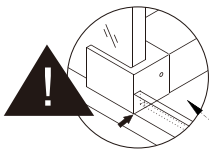

\*Measure the desired length and use a saw to cut the aluminum to the correct size. Ensure the edges are smooth and flat.

\*To ensure the threshold functions properly, apply silicone to fill the bottom gap completely. Covering the entire bottom surface.

## STEP 11

### Installation of glass door handle

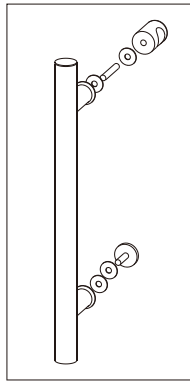
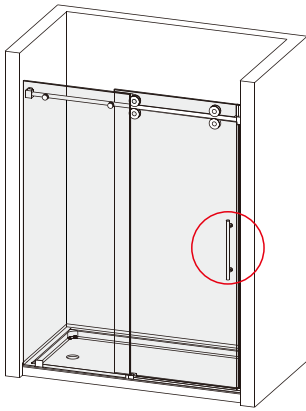

\*Install the handle and gasket then tighten the small internal pull.

## STEP 12

### Install plastic seal along the edges of both glass panels

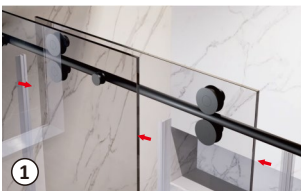
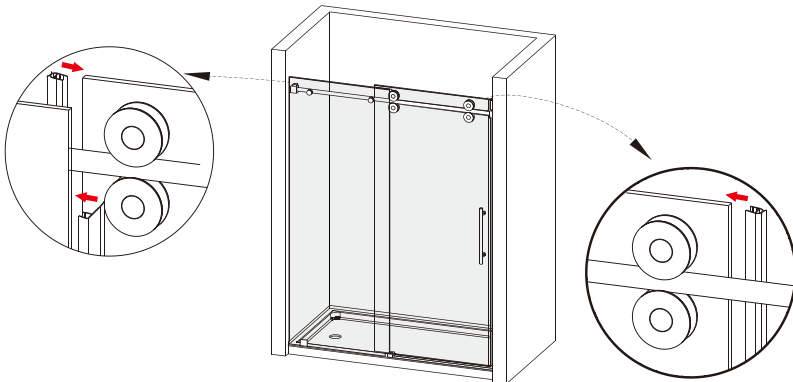

## STEP 13

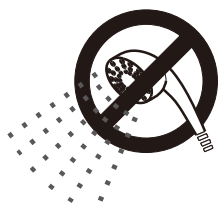
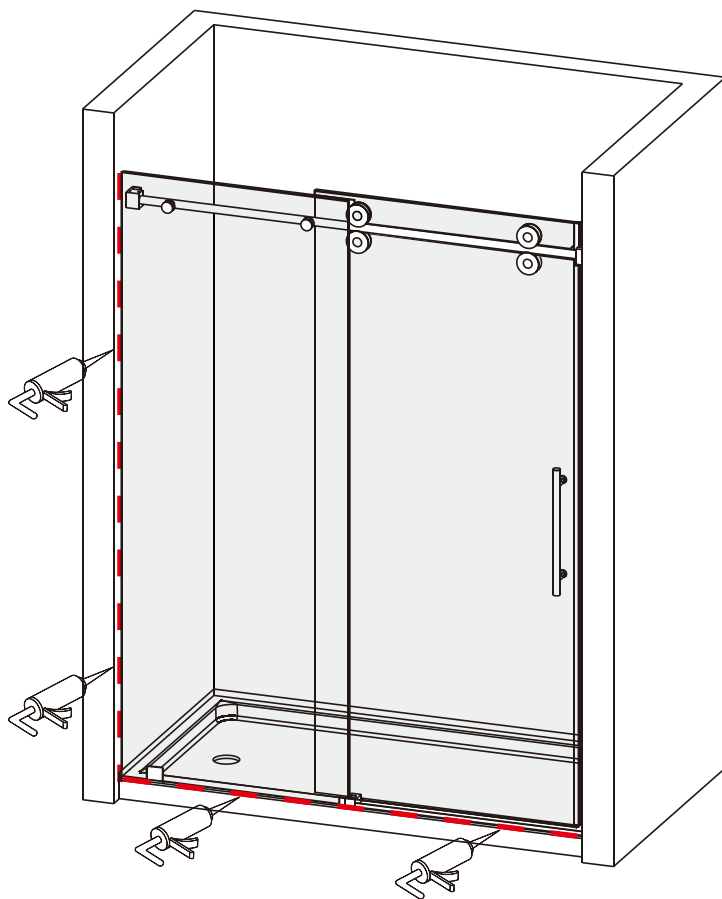

**24** HOURS

\*Wait 24 hours for the glass adhesive to cure.

# UKS04RP



\*Our products are available in a variety of colors and sizes to suit your needs.

## PARTS LIST

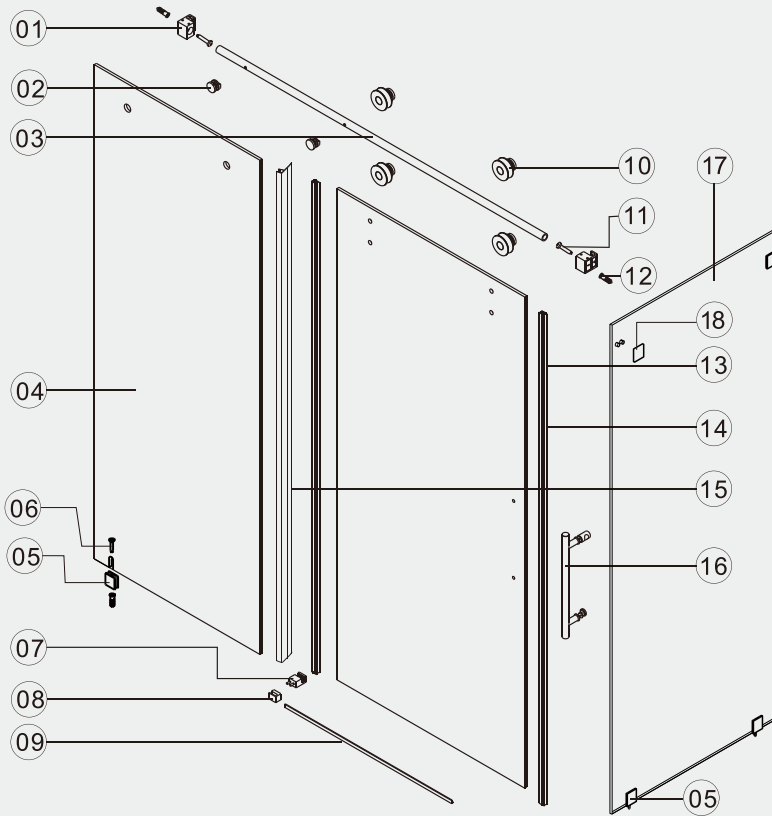

ITEM	PARTS	DIAGRAM	QTY	ITEM	PARTS	DIAGRAM	QTY
1	Wall mount bracket		2	9	Threshold		1
2	Fixed panel bracket		2	10	Ø70 Roller		4
3	Header bar		1	11	Screw St5x45		2
4	Fixed panel B		1	12	Wall anchor Ø8		6
5	Square wall clamp		4	13	Door plastic seal		2
6	Screw St5x45		4	14	Sliding door		1
7	Bottom guide for door glass		1	15	Fixed panel plastic seal		1
8	Bottom guide for fixed glass		1	16	Handle		1
17	Fixed panel B2		1	16	Return panel bracket		1

## PARTS LIST

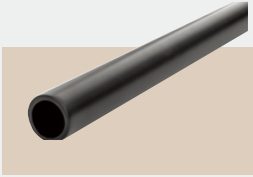

■ **UKS04HB**

Tubular Header Bar  
Length: 48"-98"  
304 Stainless Steel

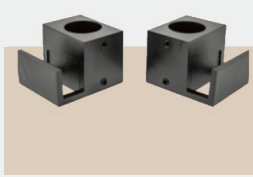

■ **WMB-UKS04**

Wall Mount Bracket  
304 Stainless Steel



■ **FPB-UKS04**

Fixed Panel Bracket  
304 Stainless Steel



■ **DRC01**

Rubber Cushion



■ **TH-L**

Aluminum Threshold



■ **GCS4**

Solid Brass  
Square Wall Clamp



■ **ROL-UKS04**

Roller - Diameter: 70mm  
304 Stainless Steel



■ **HLP12-UKS04**

12" Pull Handle  
304 Stainless Steel



■ **BG-UKS04/05**

Bottom Guide  
Length: 2-3/4"  
304/316 Stainless Steel

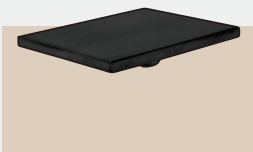

■ **RPB-UKS04/05**

Return Panel Bracket

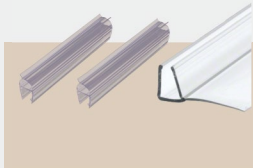

■ **PSET-SS**

2 Glass-To-Wall Sealing  
Strip and 1 Gap Fin-Seal

# SECTION DIAGRAM

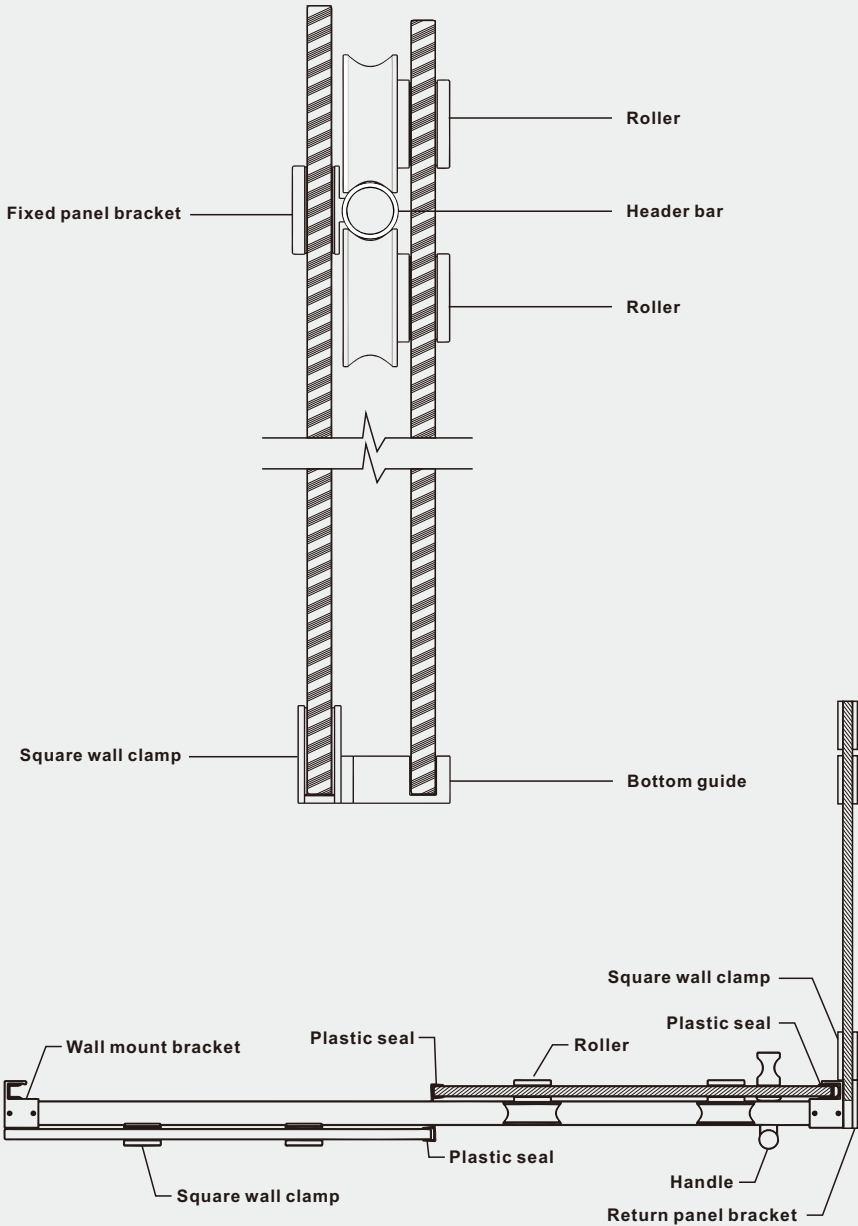



**Left**



**Right**

\*Before starting the installation, decide whether to install the door on the left or right side based on the specific conditions at the site.

### UKS04RP DRILLING GUIDE

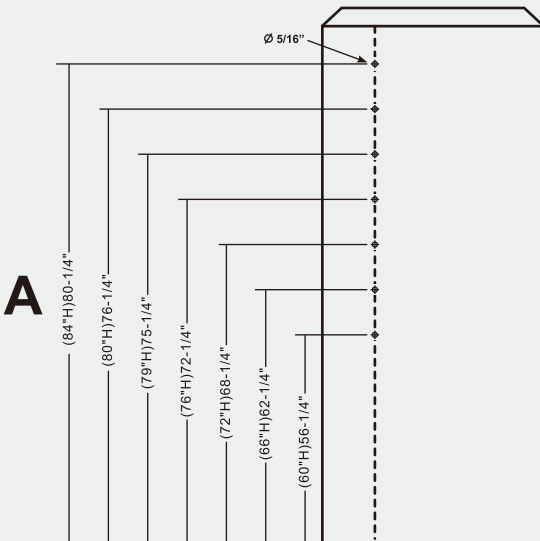

Product Height"	Header Bar Height"(A)
60"	56-1/4"
66"	62-1/4"
72"	68-1/4"
76"	72-1/4"
79"	75-1/4"
80"	76-1/4"
84"	80-1/4"

#### ATTENTION

Please verify the measurements with a tape measure before drilling any holes in the wall.

## STEP 1

### Preparation

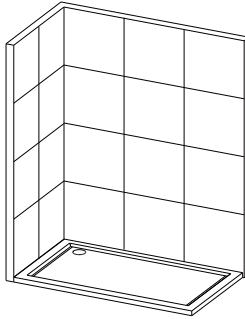

\*Carefully inspect the condition of the wall before installation. Make sure the wall surface is even and smooth.

## STEP 2

### Install Glass Panel B2

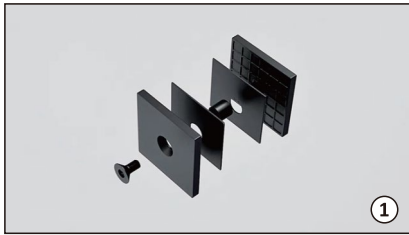

\* Disassemble the glass clamps.

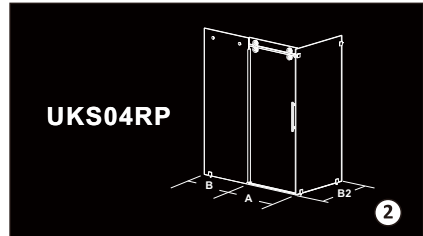

\*Ensure glass panel A and B position is within recommended unit width.

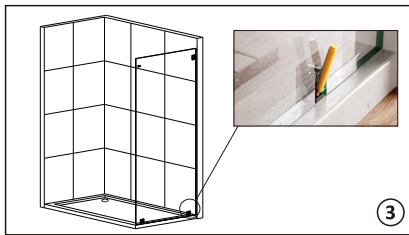

\*Position the glass clamps at the floor and wall installation points, and use a pen to mark the holes.

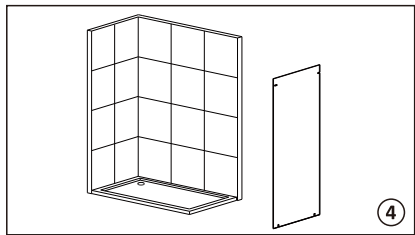

\*Move the hardware aside and place the glass in a safe location.



\*Using a 5/16" drill bit, drill holes at the marks, then insert anchors into the holes.

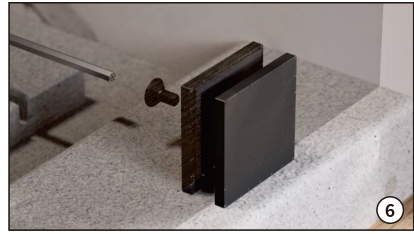

\*Install the glass clamps and securely tighten the screws..

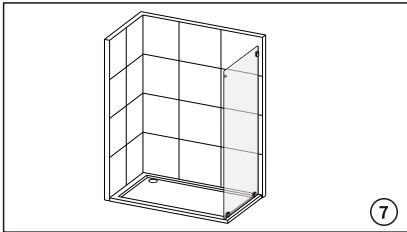

\*Re-position the glass and re-assemble the remaining components. This completes the installation of Glass Panel B2.

## STEP 3

## Installing the top header

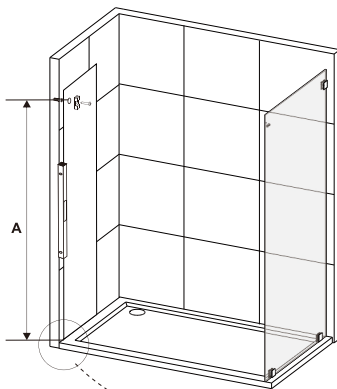

Product Height"	Header Bar Height"(A)	Product Height"	Header Bar Height"(A)
60"	56-1/4"	79"	75-1/4"
66"	62-1/4"	80"	76-1/4"
72"	68-1/4"	84"	80-1/4"
76"	72-1/4"		

\*Please verify the measurements with a tape measure before drilling any holes in the wall.

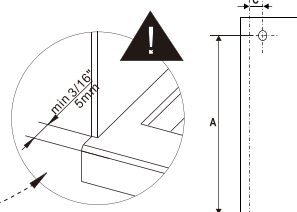

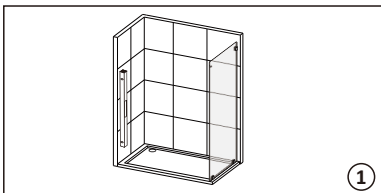

①

\*Use a spirit level or laser level to measure the wall. Once aligned horizontally, attach the height template to the wall.



②

\*Mark these locations with a pen, ensuring precision and clarity for accurate positioning during subsequent drilling.

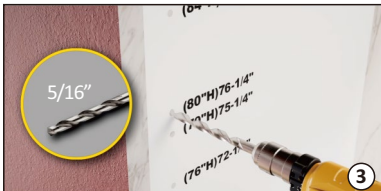

③

\*Select the appropriate hole positions according to the height of the shower door you purchased. Verify hole location using a measuring tape. Drill the holes using a 5/16\"/>

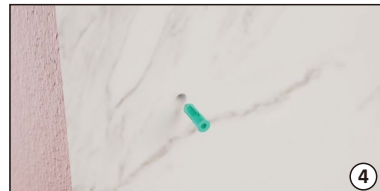

④

\*Insert wall anchors into the drilled holes.



⑤

\*Use an Allen wrench to remove the wall mount bracket covers.

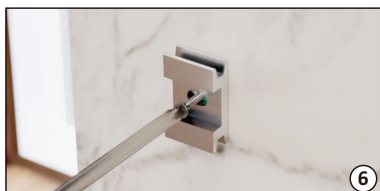

⑥

\*Align the brackets with the holes and securely tighten them with screws.

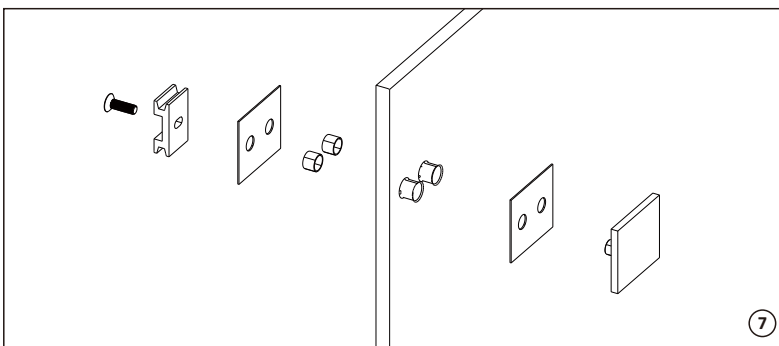

⑦

\*Attach the brackets through the hole at the top of the Return Panel Glass.

## STEP 3

### Installation of the top header

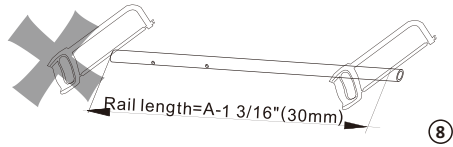
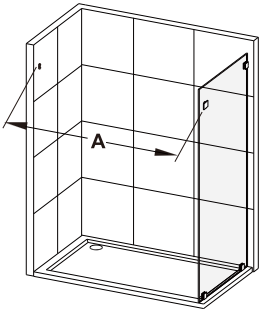

- \*Measure the desired length and use a saw to accurately cut the stainless to size, ensuring the edges are smooth and flat.
- \*When cutting the stainless steel header bar, make the cut on the side without holes to allow for adjustment.

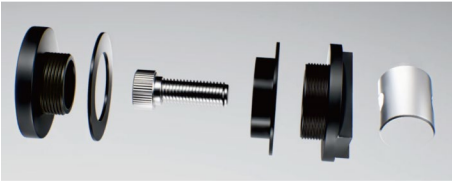

\*Disassemble the glass fixing fittings.

\*Insert the cylinder fixing blocks into the stainless steel header bar, ensuring that the holes align with the pre-drilled holes on the header bar. Then, arrange the fittings in order and secure them with screws.

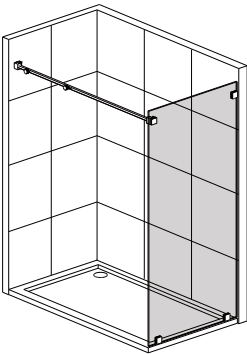

\*Insert the two wall mount bracket covers into the rails. Align them with the installed wall mount brackets and push them securely into place.

\*Use an Allen wrench to securely tighten the screws on both sides of the covers.

## STEP 4

### Installation of the glass door rollers

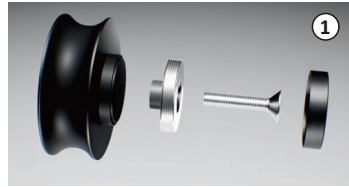
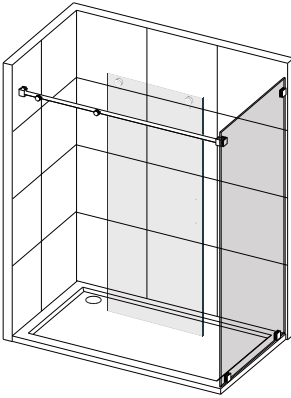

\*Place the rollers in the correct order on the holes in the glass door, after tightening the rollers using the screws and placing the inner glass inside. Please use a mat or soft cloth on the placement area to protect the door and the floor.

## STEP 5

### Installation of fixed panel and square wall clamp

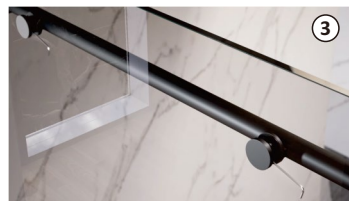
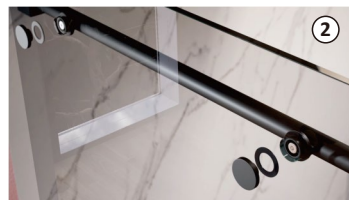
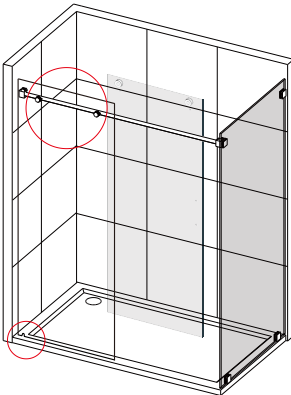

\*Secure the glass to the track first to ensure accurate installation of the bottom guide.

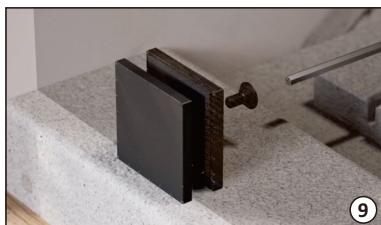
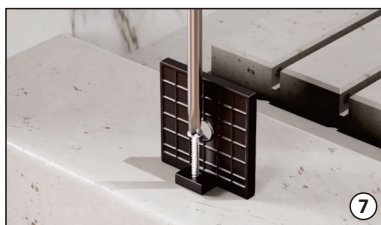
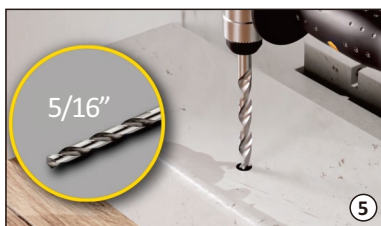
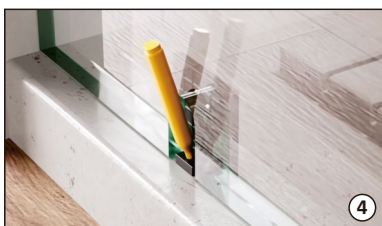

\*Use a level to ensure the glass is vertically aligned, and mark the positions of the glass clamping holes with a marker.

\*Loosen the covers, remove the glass from the track, and place it in a safe location.

\*Use a 5/16-inch drill bit to drill 5/16-inch holes.

\*Insert anchors into the ground, align the clamps with the holes. Tighten them with screws, and then install the glass gasket.

\*Align the glass-holding holes with the header bar fixed panel brackets. Install the spacers, and securely tighten the knobs using an Allen wrench.

\*At the bottom, install the gasket and cover, then securely tighten the screws from the inside using an Allen wrench.

#### WARNING



When purchasing a bathtub shower enclosure model, please install the glass clamp securely on the wall.

## STEP 6

### Installation of bottom guide

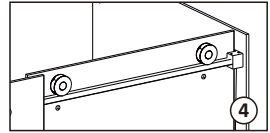
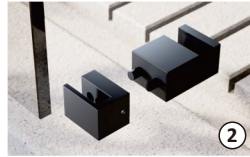
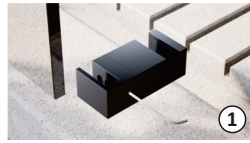
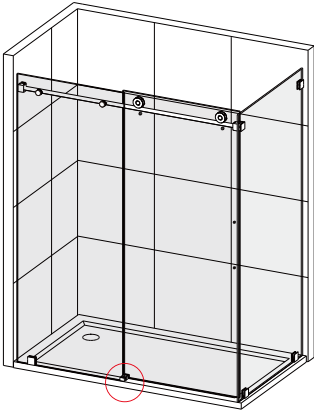

- \*Remove the bottom guide, snap the left-side piece onto the glass first, and then tighten the side screws.
- \*When installing the glass on sliding rail, ensure both wheels are securely seated and glide smoothly along the rail for safe operation.
- \*Ensure the glass snaps securely into place against the bottom guide, then push it in and tighten the screws to secure its position.

## STEP 7

### The correct method of installing glass

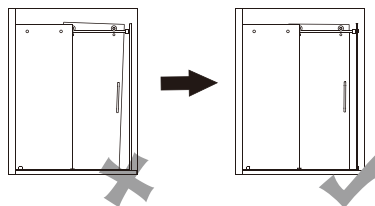
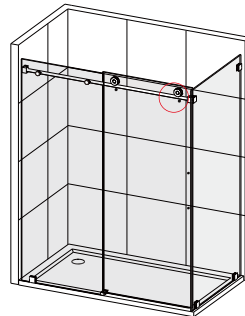
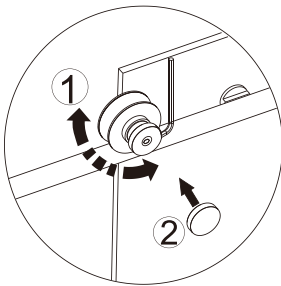

- \*If you notice that the glass is not level at the top and bottom, adjust the eccentric screw on the wheels to ensure the glass is level.

## STEP 8

### Installation of the glass door rollers

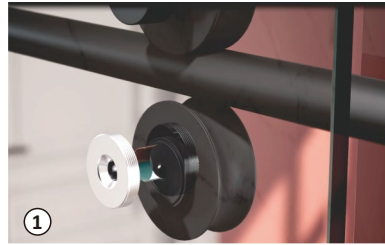
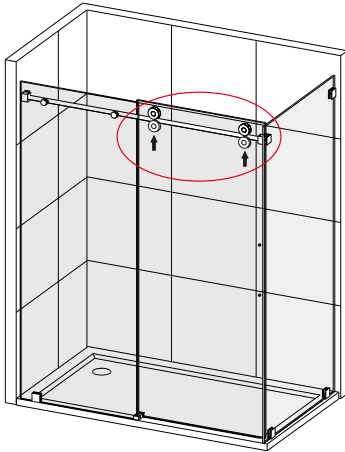

\*Once you've verified that the sliding glass door is level, adjust the bottom wheels to ensure they make contact with the track, preventing the glass from falling and reducing the risk of injury.

## STEP 9

### Installation of the water stopper in the bottom fixture recess

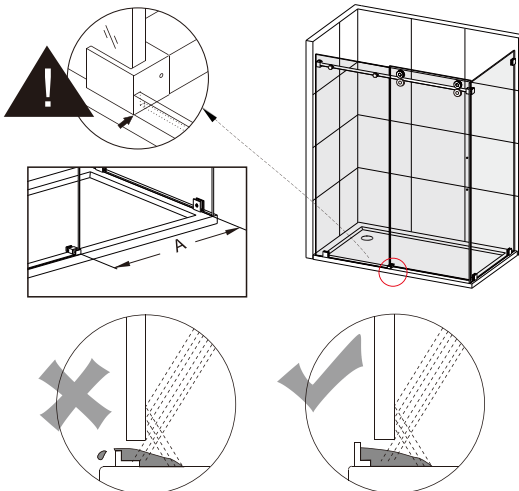

\*Measure the desired length and use a saw to cut the aluminum to the correct size. Ensure the edges are smooth and flat.

\*To ensure the threshold functions properly, apply silicone to fill the bottom gap completely. Covering the entire bottom surface.

## STEP 10

### Installation of glass door handle

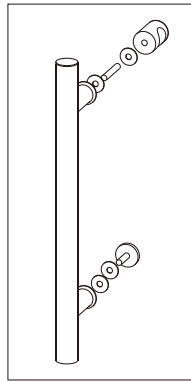
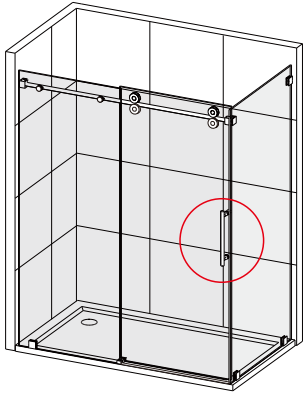

\*Install the handle and gasket then tighten the small internal pull.

## STEP 11

### Install plastic seal along the edges of both glass panels

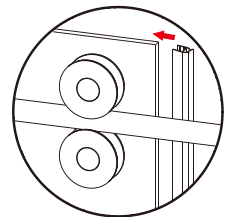
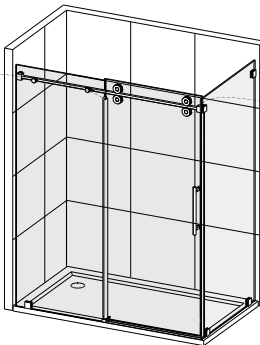
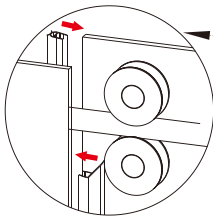

## STEP 12

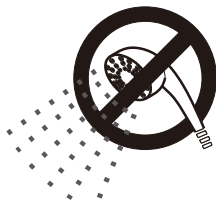
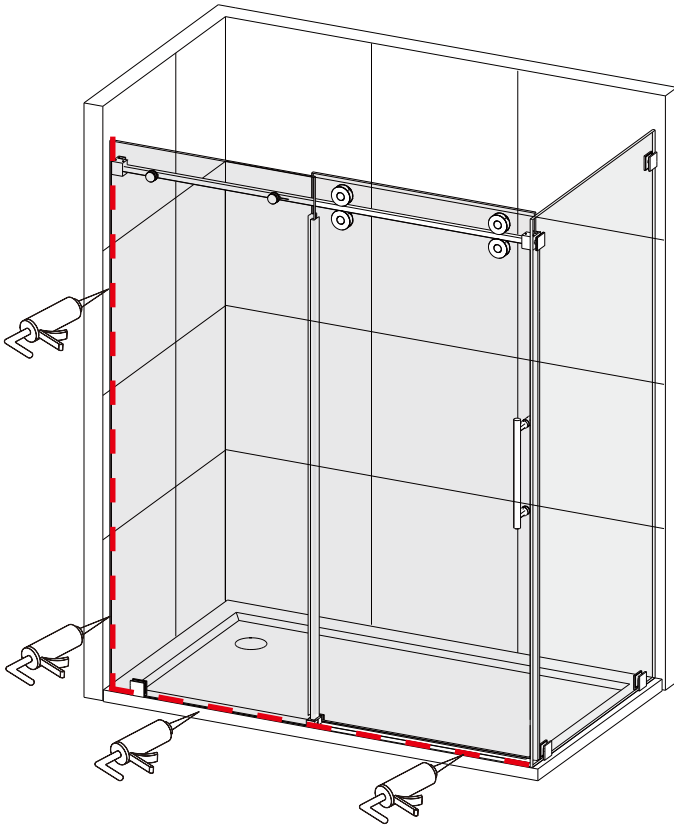

**24** HOURS

\*Wait 24 hours for the glass adhesive to cure.

# UNIKOO LIMITED WARRANTY

This warranty applies to Unikoo Glass & Hardware products purchased after January 1, 2020.

Unikoo offers the following parts only, limited warranty (for the designated period) for its products and components thereof. Unikoo's limited warranty extends only to the original owner/end-user, is for household use only (for commercial use please see COMMERCIAL USE section), and is not transferable to a subsequent owner. Unikoo reserves the right to modify this limited warranty at any time, it being understood that such modifications will not alter the limited warranty conditions applicable at the time of sale of the products in question.

This limited warranty extends for the designated period of time so long as the product remains in use in its original place of installation. This limited warranty applies only to Unikoo® products purchased from an authorized dealer in the United States or Canada. Proof of purchase (original sales receipt) from the original consumer purchase must be provided with all warranty claims.

**IN NO EVENT SHALL THE LIABILITY OF UNIKOO EXCEED THE PURCHASE PRICE OF THE PRODUCT. NO RESPONSIBILITY IS ASSUMED BY UNIKOO FOR ANY SPECIAL, INCIDENTAL OR CONSEQUENTIAL DAMAGES.**

Unikoo recommends that its products be installed by a professional with experience in the installation of bathroom (specifically shower and tub doors) products. Installation of certain products, including, without limitation, glass products (i.e., shower and tub doors) by an inexperienced installer may result in glass breakage and, consequently, may cause personal injury or even death. Installation must be in accordance with the installation manual without modification. Any deviation from the installation manual shall VOID THE WARRANTY.

## **PARTS ONLY LIMITED WARRANTY**

The limited warranty covers replacement parts for all defects for the designated period. LABOR CHARGES AND/OR DAMAGE INCURRED DURING INSTALLATION, REPAIR, OR REPLACEMENT, AS WELL AS ANY OTHER KINDS OF ANCILLARY COST, LOSS OR DAMAGE ARE EXCLUDED. Please allow 24-48 hours for processing of warranty issued parts. Once warranty replacement parts are shipped, the warranty is activated, and the product cannot be returned for refund thereafter.

## **COMMERCIAL USE**

Notwithstanding any other terms in this warranty, the duration of the applicable limited warranty excludes all industrial, commercial and business usage. THE WARRANTY PERIOD FOR PRODUCTS INSTALLED FOR COMMERCIAL APPLICATIONS OR USED IN COMMERCIAL VENTURES, INCLUDING BUT NOT LIMITED TO MOTELS, HOTELS, CASINOS, STUDENT HOUSING, CONDOS, APARTMENTS, AND FITNESS CENTERS, IS A ONE (1) YEAR LIMITED WARRANTY FROM THE DATE OF PURCHASE FOR SHOWER DOORS, BATHTUB DOORS, SHOWER ENCLOSURES, SHOWER BASES, AND BACKWALLS, WITH ALL OTHER TERMS OF THIS WARRANTY APPLYING EXCEPT THE DURATION OF THE WARRANTY.

## **OTHER EXCLUSIONS**

UNIKOO HEREBY DISCLAIMS ALL WARRANTIES, EXPRESS OR IMPLIED, FOR PRODUCTS SOLD AS DEALER OR STORE DISPLAYS, INCLUDING THE IMPLIED WARRANTIES OF MERCHANTABILITY AND FITNESS FOR A PARTICULAR PURPOSE.

## **LIMITED WARRANTY TERMS**

Unikoo will, at its election, repair or replace a product found by Unikoo, in its sole judgment, to be defective within the warranty period under normal residential use and maintenance. The replacement of a product is limited to supplying a replacement product or part (same as existing or if not available, comparable product). Unikoo's warranty obligation shall be discharged upon tender of parts, replacement, or repair of the product. Purchaser's refusal to accept the

tender terminates all warranty obligations and **VOIDS THE WARRANTY**. Cost of freight for returning products to Unikoo for repairs or replacement under this limited warranty is the responsibility of the customer. Cost of freight associated with shipping of replacement product(s) or parts covered by this limited warranty is the responsibility of the customer. Any product replaced or repaired during the warranty period will be covered only for the remaining period of the original limited warranty. In no event will Unikoo be liable for costs of repair or replacement of any installation material, including but not limited to tile, marble, etc. **UNIKOO IS NOT RESPONSIBLE FOR INSTALLATION, REMOVAL OR REINSTALLATION COSTS OF ANY PRODUCT REQUIRING WARRANTY SERVICES.**

Any modification or alteration of any Unikoo product will void the warranty. Neither the authorized Unikoo dealer, nor any other person, is permitted to make any affirmation, representation, or warranty other than those contained in this limited warranty. Any affirmation, representation, or warranty other than those contained in this limited warranty shall not be enforceable against Unikoo or any other person.

Unikoo recommends that product installations and repairs be performed by an experienced professional in accordance with the installation manual without modification. Installation or repairs that deviate from the installation manual shall **VOID THE WARRANTY**. This limited warranty shall not apply to breakage or damages caused by normal wear and tear, fault, carelessness, abuse, misuse, misapplication, improper maintenance, alteration or modification of the unit, as well as chemical or natural corrosion, accident, fire, flood, act of God or any other casualty. Improper care and cleaning will **VOID THE WARRANTY**. Use of cleaners containing abrasive cleansers, ammonia, bleach, acids, waxes, alcohol, solvents or other products not recommended for hardware finishes, glass or acrylic, as they may damage the metal or glass finish of your product, will **VOID THE WARRANTY**. For additional product maintenance instructions, please refer to the product installation manual. Unikoo is not responsible for any issues arising in connection with errors or omissions in information provided on Unikoo or dealers' websites. This limited warranty does not extend to any non-Unikoo plumbing or components installed by installers, end users or by any party other than Unikoo.

THE FOREGOING LIMITED WARRANTIES ARE IN LIEU OF ALL OTHER WARRANTIES, EXPRESS OR IMPLIED, INCLUDING BUT NOT LIMITED TO THE IMPLIED WARRANTIES OF MERCHANTABILITY AND FITNESS FOR A PARTICULAR PURPOSE. UNIKOO DISCLAIMS ALL LIABILITY FOR SPECIAL, INCIDENTAL OR CONSEQUENTIAL DAMAGES. UNIKOO IS NOT LIABLE FOR PERSONAL INJURIES OR DEATH TO ANY PERSON OR FOR ANY INDIRECT, SPECIAL, INCIDENTAL OR CONSEQUENTIAL DAMAGES, LOSS OF USE, LOSS OF TIME, LOSS OF PROFITS, INCONVENIENCE, INCIDENTAL EXPENSES, LABOR OR MATERIAL CHARGES, OR ANY OTHER COSTS RESULTING FROM THE USE OF ITS PRODUCTS OR PERTAINING TO THE APPLICATION OF THE PRESENT WARRANTY OR RESULTING FROM THE REMOVAL OR REPLACEMENT OF ANY PRODUCT OR PART COVERED BY THIS WARRANTY.

## **PRODUCT WARRANTY PERIODS**

The laws and regulations that govern the installation and use of shower or tub doors, shower enclosures, and other accessories vary widely by region, state or municipality. Except as otherwise provided above, Unikoo makes no warranties, express or implied, including warranties of merchantability and fitness for a particular purpose, or compliance with any code. Unikoo is not responsible for verifying building code restrictions on installation or use, and any such compliance is excluded from this warranty. Unikoo reserves the right to modify this limited warranty at any time - such warranty modifications will not alter the warranty applicable at the time of sale of the products in question. The warranty periods for specific products for consumer (non-industrial, non-commercial, non-business use only) are as specified below:

### **3 Years Limited Warranty – SHOWER DOOR HARDWARE, TUB DOOR HARDWARE, AND SHOWER ENCLOSURE HARDWARE**

The Unikoo 3 Years Limited Warranty covers all shower door, tub door, and shower enclosure hardware, with the exception of glass. Unikoo warrants shower door, tub door and shower enclosure hardware (i.e. handles, rollers, hinges, profiles, clips, guides, brackets, towel bars) in chrome and brushed nickel finishes only to be free from defects in workmanship and materials under normal residential use for a period commencing from the initial date of purchase by the owner/ end-user, contractor or builder from an authorized Unikoo dealer for the life of the product as long as the original consumer purchaser resides in the home in which the product is installed. **THE WARRANTY PERIOD FOR ANY COATING ON HARDWARE IN SATIN BRASS, SPACE GRAY OR MATTE BLACK FINISH SHALL BE LIMITED TO ONE (1) YEAR. THE WARRANTY PERIOD FOR PLASTIC SEAL STRIPS, SWEEPS OR ANY OTHER VINYL COMPONENTS SHALL BE LIMITED TO ONE (1) YEAR. UNIKOO DOES NOT WARRANT GLASS FOR SCRATCHES, CHIPS, WATER SPOTS, BREAKING OR ANY OTHER DAMAGE DURING OR AFTER INSTALLATION.**

## **One (1) Year Limited Warranty - FAUCETS, ACCESSORIES AND SHOWER HEADS**

Unikoo shower accessories are backed by a One (1) Year Limited Warranty. Unikoo warrants shower columns purchased by the owner/end-user, contractor or builder from an authorized Unikoo dealer to be free from defects in workmanship and materials under normal residential use for a period of one (1) year from the date of purchase of the product as long as the original consumer purchaser resides in the home in which the product is installed.

## **One (1) Year Limited Warranty – COMMERCIAL HARDWARE AND RAILING SYSTEMS**

The Unikoo One (1) Year Limited Warranty covers all commercial hardware and railing system, with the exception of glass. All warranty claims are subject to inspection by UNIKOO before providing a resolution against the warranty claim. This warranty is void if it is determined after UNIKOO inspection that the Hardware has been improperly installed and/or maintained in a manner not conforming to UNIKOO guidelines and instructions provided at time of purchase. UNIKOO's responsibility to provide a resolution under said warranty will be limited to a refund of purchased price or provide a replacement for the hardware. The refund or replacement will constitute UNIKOO's limited liability and obligation for any and all defective material/workmanship for said warranty claim.

## **STATE LAWS AND THIS WARRANTY**

Some states/provinces do not allow limitations on how long an implied warranty lasts, or the exclusion or limitation of special, incidental or consequential damages, so these limitations and exclusions may not apply to you. This warranty gives you specific legal rights. You may also have other rights, which vary from state to state or province to province.

## **WARRANTY SERVICE**

**To file a warranty claim, the following information is required:**

- Name, address and telephone number
- Product model number, color, finish
- Complete description of problem (please note that additional information such as photos may be required to fully process your warranty claim)
- Date of purchase and from whom the product was purchased
- Proof of purchase (sales receipt, invoice, etc.)
- PO, Invoice or original purchaser name

**Submit required information by email or mail:**

Email: [info@unikoo.com](mailto:info@unikoo.com)

Mailing Address: Unikoo Warranty Service Center

1820 S Santa Fe St, Santa Ana, CA 92705

or contact Technical Support at 888-404-5533 Monday - Friday 7:00 am - 4:00 pm PST

## OTHER MODELS

