

# UKH10

## INSTRUCTION MANUAL

Scan for Installation Video



(UKH10)



***Please keep this manual and the product code number for future reference and to order replacement parts if necessary***

### GENERAL INSTRUCTIONS

- Please read this manual carefully and thoroughly before proceeding.
- For your safety, it is recommended that you wear safety glasses at all times during installation.

### INSTALLATION OVER CERAMIC TILES

- If you are installing the shower door over ceramic tiles, make sure that the tiles lay completely under the wall jamb.
- Use mildew resistant silicone to seal the gaps where the ceramic tiles meet the fixed panel.









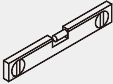

### NOTICE

- Caulking is not required inside the shower, unless otherwise stated.
- Some models are equipped with clear sealing gaskets.

### CARE FOR YOUR SHOWER DOOR

- Do not use scouring powder pads or sharp instruments on metal pieces or glass panels.
- To keep the panels and metal parts looking new, occasionally wipe them down with a mild soap diluted in water.
- We recommend wiping the glass panels with a squeegee after each use.

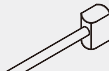
## TOOLS REQUIRED

 SPIRIT LEVEL	 TAPE MEASURE	 POWER DRILL	 DRILL BITS	 SILICONE
 SCREW DRIVER	 PENCIL	 UTILITY KNIFE	 MALLET	 SAFETY GLASSES



2 PEOPLE REQUIRED

Product specifications are subject to change without notice.

# UKH10



\*Our products are available in a variety of colors and sizes to suit your needs.

## PARTS LIST

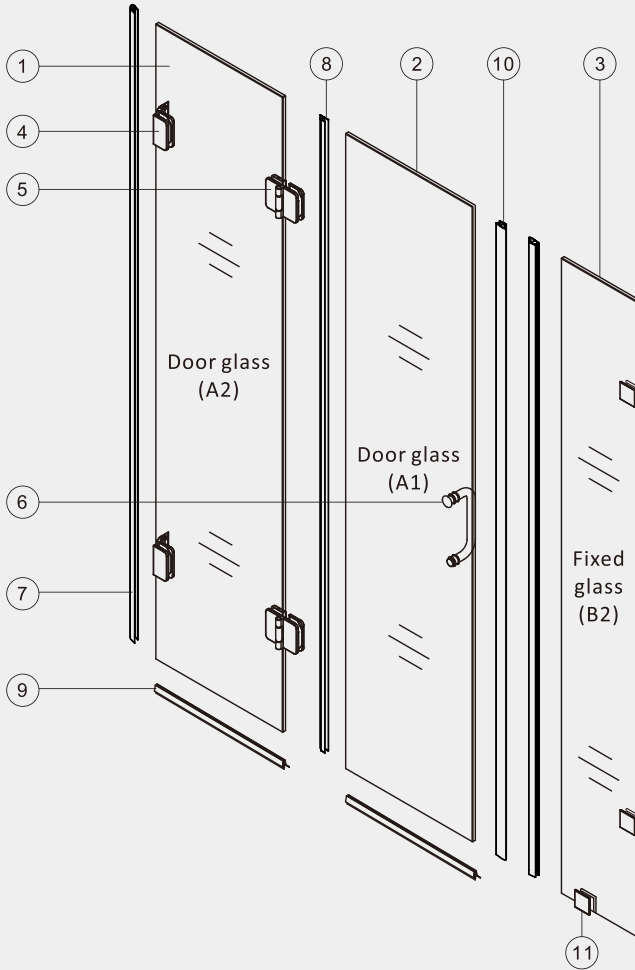

ITEM	PARTS	DIAGRAM	QTY	ITEM	PARTS	DIAGRAM	QTY
1	Door glass		1	8	Plastic seal		2
2	Door glass		1	9	Plastic seal		2
3	Fixed glass		1	10	Magnetic PVC seal		2
4	Wall hinges		2	11	Wall clamp		3
5	Lever hinges		2				
6	Single handle		1				
7	Plastic seal		1				

## PARTS LIST



■ **LH-86.2/4**

180° Glass to Glass Lever Hinge



■ **LH-86RV**

Wall Hinge



■ **HBM8**

Tubular Single Sided Handle  
8" CTC hole spacing



■ **GCS4**

Square Hole-In-Glass Fixed  
Panel U-Clamp

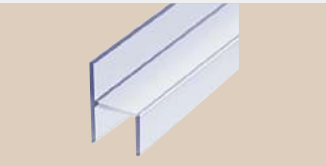

■ **PDJ-180-3/8-96**

Swing Door 180° In-Line Door-To-Fixed  
Panel Door Strike Jamb w/Seal-96"

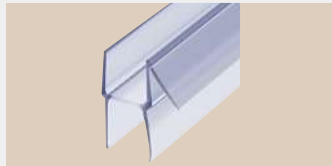

■ **PBW-DR-32**

Swing Door Bottom Wipe w/ 45°  
Drip Rail & 2 Vinyl Sweeps



■ **PBLB-84**

Translucent Vinyl Bulb Seal



■ **PDJ-90/180-MG-3/8-80**

180 Degree Magnetic Door Strike  
Jamb Seal for 3/8" Glass

## STEP 1

## Wall Hinge Installation



\*Disassembling the wall hinge. Be sure to rotate the set screw clockwise into the hinge when removing the cover plate as to not damage the cover plate.

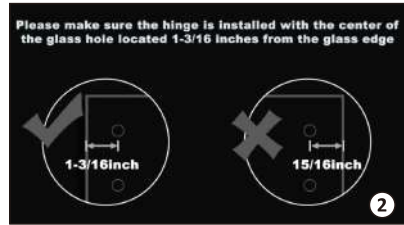

\*Please make sure the hinge is installed with the center of the glass hole located 1-3/16 inches from the glass edge.



\*At the same time, make sure that the glass surface is clean, dust-free, and free of oil stains.



\*Install the disassembled wall hinge components onto the glass and securely tighten the screws. When attaching the decorative cover, rotate the screw counterclockwise until the cover is firmly held in place in the upward position.

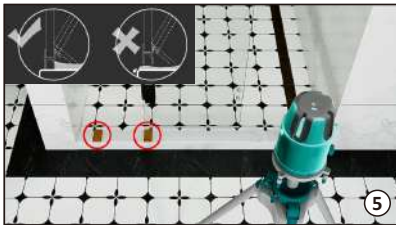

\*It is highly recommended to use a laser level to ensure precise hole alignment.  
\*To ensure the bottom water seal functions properly, place shims that match the height of the water seal.



\*Have one person hold the glass in place as the other marks the hinge drill hole locations. Once the panel is properly positioned, use a marker to make clear and precise marks.

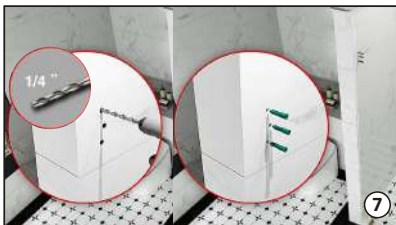

\*Attach a 1/4" drill bit securely to the electric drill. Drill carefully at the marked locations.  
\*When drilling into the tile, use a slow speed to avoid cracking the tile.  
\*Insert the wall anchor firmly into the hole.



\*Tighten the screws sequentially from top to bottom to ensure a secure and stable installation.

## STEP 2

### Door Hinge Installation



\*Disassembling the glass to glass hinge.



\*Install the disassembled glass to glass hinge components onto the glass and securely tighten the screws. When attaching the decorative cover, rotate the screw counterclockwise until the cover is firmly held in place in the upward position.



\*Reposition the shims to ensure proper setup for the upcoming glass installation.



\*Gently lift the glass and place it steadily onto the shims. Adjust the position until the hinge mounting holes align precisely with the holes in the glass. Use a screwdriver to tighten the screws evenly, ensuring the hinge is firmly secured. Finally, attach the decorative cover and fasten it with the screw to complete the installation.

## STEP 3

### Door Handle Installation



\*Disassemble the door handle, then align it with the top and bottom holes on the glass to begin installation.

## STEP 4

### Magnetic PVC Seal Installation

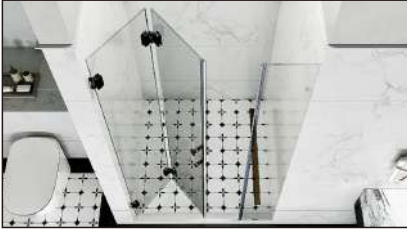

- \*Attach the magnetic shower door seal to the door. Fully open the door and keep the work area clear to facilitate easy installation.
- \*Install the other magnetic shower door seal on the fixed glass for accurate positioning.

## STEP 5

### Fixed Glass Panel Installation

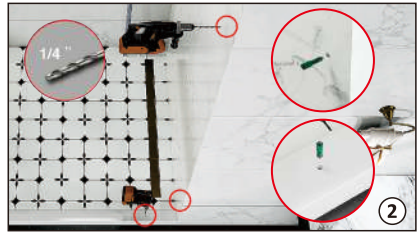
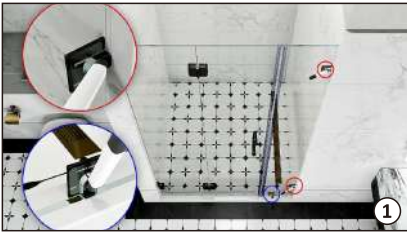

- \*Place the glass clamps and position them at the three designated drilling points, then mark each location clearly with a marker.

- \*Use a 1/4" drill bit to drill carefully at the marked locations. When drilling into tiles, use a slow speed to avoid cracking. Insert the wall anchor firmly into the hole.

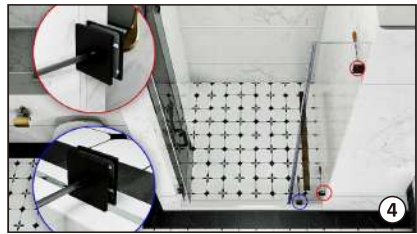

- \*Fasten the glass clamp to the wall using screws.

- \*Carefully lift the glass to reposition it, then install the remaining glass clamp hardware and secure it with screws to complete the installation.

## STEP 6

## Shower Door Sealing Strip Installation

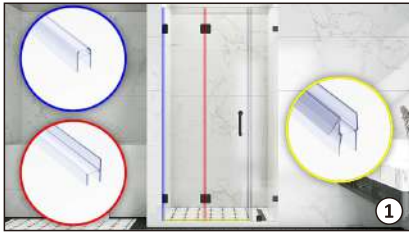

\*Install the sealing strips according to the color indicators.



\***Important:** At the two marked strips points, carefully trim the sealing strips with a utility knife to ensure a precise fit.

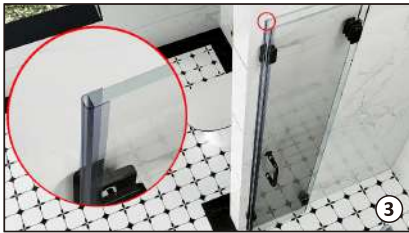

\*Install the bulb seal on the door glass where it meets the wall, ensuring proper attachment.



\*Install the L-shaped door seal at the bottom of the glass door.



\*Attach the jamb water seal to the opposite side of the glass, then close the door to check the seal.

## OPTIONAL

## U-Channel



\*If the wall is out of plumb, it is recommended to install a U-channel to properly align the glass.

## STEP 7



\*Apply silicone around wall edges of the fixed panel glass to seal any gaps From water leakage.

\*Wait 24 hours for the silicone to cure

# UNIKOO LIMITED WARRANTY

This warranty applies to Unikoo Glass & Hardware products purchased after January 1, 2020.

Unikoo offers the following parts only, limited warranty (for the designated period) for its products and components thereof. Unikoo's limited warranty extends only to the original owner/end-user, is for household use only (for commercial use please see COMMERCIAL USE section), and is not transferable to a subsequent owner. Unikoo reserves the right to modify this limited warranty at any time, it being understood that such modifications will not alter the limited warranty conditions applicable at the time of sale of the products in question.

This limited warranty extends for the designated period of time so long as the product remains in use in its original place of installation. This limited warranty applies only to Unikoo® products purchased from an authorized dealer in the United States or Canada. Proof of purchase (original sales receipt) from the original consumer purchase must be provided with all warranty claims.

**IN NO EVENT SHALL THE LIABILITY OF UNIKOO EXCEED THE PURCHASE PRICE OF THE PRODUCT. NO RESPONSIBILITY IS ASSUMED BY UNIKOO FOR ANY SPECIAL, INCIDENTAL OR CONSEQUENTIAL DAMAGES.**

Unikoo recommends that its products be installed by a professional with experience in the installation of bathroom (specifically shower and tub doors) products. Installation of certain products, including, without limitation, glass products (i.e., shower and tub doors) by an inexperienced installer may result in glass breakage and, consequently, may cause personal injury or even death. Installation must be in accordance with the installation manual without modification. Any deviation from the installation manual shall VOID THE WARRANTY.

## **PARTS ONLY LIMITED WARRANTY**

The limited warranty covers replacement parts for all defects for the designated period. LABOR CHARGES AND/OR DAMAGE INCURRED DURING INSTALLATION, REPAIR, OR REPLACEMENT, AS WELL AS ANY OTHER KINDS OF ANCILLARY COST, LOSS OR DAMAGE ARE EXCLUDED. Please allow 24-48 hours for processing of warranty issued parts. Once warranty replacement parts are shipped, the warranty is activated, and the product cannot be returned for refund thereafter.

## **COMMERCIAL USE**

Notwithstanding any other terms in this warranty, the duration of the applicable limited warranty excludes all industrial, commercial and business usage. THE WARRANTY PERIOD FOR PRODUCTS INSTALLED FOR COMMERCIAL APPLICATIONS OR USED IN COMMERCIAL VENTURES, INCLUDING BUT NOT LIMITED TO MOTELS, HOTELS, CASINOS, STUDENT HOUSING, CONDOS, APARTMENTS, AND FITNESS CENTERS, IS A ONE (1) YEAR LIMITED WARRANTY FROM THE DATE OF PURCHASE FOR SHOWER DOORS, BATHTUB DOORS, SHOWER ENCLOSURES, SHOWER BASES, AND BACKWALLS, WITH ALL OTHER TERMS OF THIS WARRANTY APPLYING EXCEPT THE DURATION OF THE WARRANTY.

## **OTHER EXCLUSIONS**

UNIKOO HEREBY DISCLAIMS ALL WARRANTIES, EXPRESS OR IMPLIED, FOR PRODUCTS SOLD AS DEALER OR STORE DISPLAYS, INCLUDING THE IMPLIED WARRANTIES OF MERCHANTABILITY AND FITNESS FOR A PARTICULAR PURPOSE.

## **LIMITED WARRANTY TERMS**

Unikoo will, at its election, repair or replace a product found by Unikoo, in its sole judgment, to be defective within the warranty period under normal residential use and maintenance. The replacement of a product is limited to supplying a replacement product or part (same as existing or if not available, comparable product). Unikoo's warranty obligation shall be discharged upon tender of parts, replacement, or repair of the product. Purchaser's refusal to accept the

tender terminates all warranty obligations and VOIDS THE WARRANTY. Cost of freight for returning products to Unikoo for repairs or replacement under this limited warranty is the responsibility of the customer. Cost of freight associated with shipping of replacement product(s) or parts covered by this limited warranty is the responsibility of the customer. Any product replaced or repaired during the warranty period will be covered only for the remaining period of the original limited warranty. In no event will Unikoo be liable for costs of repair or replacement of any installation material, including but not limited to tile, marble, etc. **UNIKOO IS NOT RESPONSIBLE FOR INSTALLATION, REMOVAL OR REINSTALLATION COSTS OF ANY PRODUCT REQUIRING WARRANTY SERVICES.**

Any modification or alteration of any Unikoo product will void the warranty. Neither the authorized Unikoo dealer, nor any other person, is permitted to make any affirmation, representation, or warranty other than those contained in this limited warranty. Any affirmation, representation, or warranty other than those contained in this limited warranty shall not be enforceable against Unikoo or any other person.

Unikoo recommends that product installations and repairs be performed by an experienced professional in accordance with the installation manual without modification. Installation or repairs that deviate from the installation manual shall **VOID THE WARRANTY**. This limited warranty shall not apply to breakage or damages caused by normal wear and tear, fault, carelessness, abuse, misuse, misapplication, improper maintenance, alteration or modification of the unit, as well as chemical or natural corrosion, accident, fire, flood, act of God or any other casualty. Improper care and cleaning will **VOID THE WARRANTY**. Use of cleaners containing abrasive cleansers, ammonia, bleach, acids, waxes, alcohol, solvents or other products not recommended for hardware finishes, glass or acrylic, as they may damage the metal or glass finish of your product, will **VOID THE WARRANTY**. For additional product maintenance instructions, please refer to the product installation manual. Unikoo is not responsible for any issues arising in connection with errors or omissions in information provided on Unikoo or dealers' websites. This limited warranty does not extend to any non-Unikoo plumbing or components installed by installers, end users or by any party other than Unikoo.

THE FOREGOING LIMITED WARRANTIES ARE IN LIEU OF ALL OTHER WARRANTIES, EXPRESS OR IMPLIED, INCLUDING BUT NOT LIMITED TO THE IMPLIED WARRANTIES OF MERCHANTABILITY AND FITNESS FOR A PARTICULAR PURPOSE. UNIKOO DISCLAIMS ALL LIABILITY FOR SPECIAL, INCIDENTAL OR CONSEQUENTIAL DAMAGES. UNIKOO IS NOT LIABLE FOR PERSONAL INJURIES OR DEATH TO ANY PERSON OR FOR ANY INDIRECT, SPECIAL, INCIDENTAL OR CONSEQUENTIAL DAMAGES, LOSS OF USE, LOSS OF TIME, LOSS OF PROFITS, INCONVENIENCE, INCIDENTAL EXPENSES, LABOR OR MATERIAL CHARGES, OR ANY OTHER COSTS RESULTING FROM THE USE OF ITS PRODUCTS OR PERTAINING TO THE APPLICATION OF THE PRESENT WARRANTY OR RESULTING FROM THE REMOVAL OR REPLACEMENT OF ANY PRODUCT OR PART COVERED BY THIS WARRANTY.

## **PRODUCT WARRANTY PERIODS**

The laws and regulations that govern the installation and use of shower or tub doors, shower enclosures, and other accessories vary widely by region, state or municipality. Except as otherwise provided above, Unikoo makes no warranties, express or implied, including warranties of merchantability and fitness for a particular purpose, or compliance with any code. Unikoo is not responsible for verifying building code restrictions on installation or use, and any such compliance is excluded from this warranty. Unikoo reserves the right to modify this limited warranty at any time - such warranty modifications will not alter the warranty applicable at the time of sale of the products in question. The warranty periods for specific products for consumer (non-industrial, non-commercial, non-business use only) are as specified below:

### **3 Years Limited Warranty – SHOWER DOOR HARDWARE, TUB DOOR HARDWARE, AND SHOWER ENCLOSURE HARDWARE**

The Unikoo 3 Years Limited Warranty covers all shower door, tub door, and shower enclosure hardware, with the exception of glass. Unikoo warrants shower door, tub door and shower enclosure hardware (i.e. handles, rollers, hinges, profiles, clips, guides, brackets, towel bars) in chrome and brushed nickel finishes only to be free from defects in workmanship and materials under normal residential use for a period commencing from the initial date of purchase by the owner/ end-user, contractor or builder from an authorized Unikoo dealer for the life of the product as long as the original consumer purchaser resides in the home in which the product is installed. THE WARRANTY PERIOD FOR ANY COATING ON HARDWARE IN SATIN BRASS, SPACE GRAY OR MATTE BLACK FINISH SHALL BE LIMITED TO ONE (1) YEAR. THE WARRANTY PERIOD FOR PLASTIC SEAL STRIPS, SWEEPS OR ANY OTHER VINYL COMPONENTS SHALL BE LIMITED TO ONE (1) YEAR. UNIKOO DOES NOT WARRANT GLASS FOR SCRATCHES, CHIPS, WATER SPOTS, BREAKING OR ANY OTHER DAMAGE DURING OR AFTER INSTALLATION.

## One (1) Year Limited Warranty - FAUCETS, ACCESSORIES AND SHOWER HEADS

Unikoo shower accessories are backed by a One (1) Year Limited Warranty. Unikoo warrants shower columns purchased by the owner/end-user, contractor or builder from an authorized Unikoo dealer to be free from defects in workmanship and materials under normal residential use for a period of one (1) year from the date of purchase of the product as long as the original consumer purchaser resides in the home in which the product is installed.

## One (1) Year Limited Warranty – COMMERCIAL HARDWARE AND RAILING SYSTEMS

The Unikoo One (1) Year Limited Warranty covers all commercial hardware and railing system, with the exception of glass. All warranty claims are subject to inspection by UNIKOO before providing a resolution against the warranty claim. This warranty is void if it is determined after UNIKOO inspection that the Hardware has been improperly installed and/or maintained in a manner not conforming to UNIKOO guidelines and instructions provided at time of purchase. UNIKOO's responsibility to provide a resolution under said warranty will be limited to a refund of purchased price or provide a replacement for the hardware. The refund or replacement will constitute UNIKOO's limited liability and obligation for any and all defective material/workmanship for said warranty claim.

## STATE LAWS AND THIS WARRANTY

Some states/provinces do not allow limitations on how long an implied warranty lasts, or the exclusion or limitation of special, incidental or consequential damages, so these limitations and exclusions may not apply to you. This warranty gives you specific legal rights. You may also have other rights, which vary from state to state or province to province.

## WARRANTY SERVICE

**To file a warranty claim, the following information is required:**

- Name, address and telephone number
- Product model number, color, finish
- Complete description of problem (please note that additional information such as photos may be required to fully process your warranty claim)
- Date of purchase and from whom the product was purchased
- Proof of purchase (sales receipt, invoice, etc.)
- PO, Invoice or original purchaser name

**Submit required information by email or mail:**

Email: [info@unikoo.com](mailto:info@unikoo.com)

Mailing Address: Unikoo Warranty Service Center

1820 S Santa Fe St, Santa Ana, CA 92705

or contact Technical Support at 888-404-5533 Monday - Friday 7:00 am - 4:00 pm PST

